

HT 
ENTERPRISES, INC TM

YOUR **ICE** FISHING EXPERTS



**“OVER 45 YEARS
SATISFYING THE PROS”**

**2022-2023
WINTER CATALOG
WWW.HTENT.COM**



Dear Customer,

Premium Gear Since 1972

We at HT Enterprises, Inc., would like to thank you for showing an interest in our ice fishing product line. Over the years we have worked hard to design and manufacture products that you would be proud to market.

Our line of ice fishing tackle has been well received throughout the United States, Canada, and the World. Our products have weathered the "test of time" and have proven to be very popular among ice fishing enthusiasts everywhere.

Our number one goal is to continue to offer the very best ice fishing tackle in the world. We will continue to do everything possible to keep the cost of manufacturing down, so that you will always remain competitive in the marketplace. Our wholesale-buying discount program has been designed to achieve maximum volume and high profits.

If you have any questions concerning our product line or discount program terms, please give us a call at 920-533-5080. Our office hours are from 8:00 a.m. to 4:00 p.m. daily (Central Time).

Again, we'd like to thank you for your interest in our line of ice fishing tackle products. We will continue to do everything possible to serve you.

2022-23 Ordering Program

In order to provide you with quality product and on-time deliveries at competitive prices we need to be able to place orders on a timely basis with our suppliers.

- Late orders to our suppliers starts an unfortunate chain of events starting with late shipments to customers and lost sales.
- Quality diminishes quickly when suppliers must rush production to try and meet unreasonable deadlines. Without ample production time quality control is not able to catch problems that normally would be easily resolved.
- Rush orders always demand higher production costs and unusual shipping arrangements that add unnecessary costs increasing the cost of your products.

➔ **We can greatly diminish the above situations with timely ordering. We depend on you to evaluate your product needs at the end of the ice fishing season.**

- 1) **Count your inventory as you are storing the remaining stock**
- 2) **Record your sales quantities for each ice fishing item**
- 3) **Mark the items to go forward and items to drop**
- 4) **Subtract sales from remaining inventory quantities**
- 5) **Provide a 2022 forecast to your HT representative Before 3/1/2022**

Please Place Opening Orders Before March 1st, 2022

HT Enterprises, Inc strives to fill every order no matter when the order is placed. Unfortunately, it is impossible to produce the exact amount of product needed without customer forecasts.

Opening orders placed after midnight, **March 1st, 2022** will reduce our ability to supply all of your product needs through the season.

Items that have minimum customer support will be evaluated after the March 1st deadline. If quantities ordered do not meet supplier minimums, HT Enterprises, Inc. will contact you and hopefully find a way to reach the minimums needed.

Note: All Orders INCLUDE a 3% Defective Goods Allowance in your NET Invoice Price
If you would like to be credited for defectives, quoted prices will be raised 3%

(800) 216-5184 Fax: (920) 533-5147

HT ENTERPRISES, INC. • PO BOX 909 • CAMPBELLSPORT • WISCONSIN 53010
SHIPPING ADDRESS: 139 EAST SHEBOYGAN STREET

SIBERIAN TIGER HARDCORE ICE GEAR **PREMIUM ICE AUGER KIT**



Unique Locking Mechanism!

- Auger flighting coated with an ice resistant non-stick finish
- Kit comes complete with adjustable handle, auger, 22" extension bar and ultra-smooth drill adapter
- Superior steel construction holds up against harsh weather
- Adjustable telescopic handle lets you choose the correct height from 36" to 56"
- Handle folds down for easy transport and storage
- Super sharp and specially hardened steel serrated chipping blades help make drilling holes fast and easy
- Unique quick folding/locking handle mechanism prevents backlash



Part No.
SBT-6 6" Auger Kit
SBT-8 8" Auger Kit

Part No.
SBTB-6 6" Replacement Blade
SBTB-8 8" Replacement Blade

Ice Resistant
Non-Stick
Finish

SIBERIAN Ice Auger Kit HARDCORE ICE GEAR

- Kit comes complete with adjustable handle, auger, 22" extension bar and ultra-smooth drill adapter
- Superior steel construction holds up against harsh weather
- Handle folds down for easy transport and storage
- Adjustable telescopic handle
- Super sharp and specially hardened steel serrated chipping blades help make drilling holes fast and easy

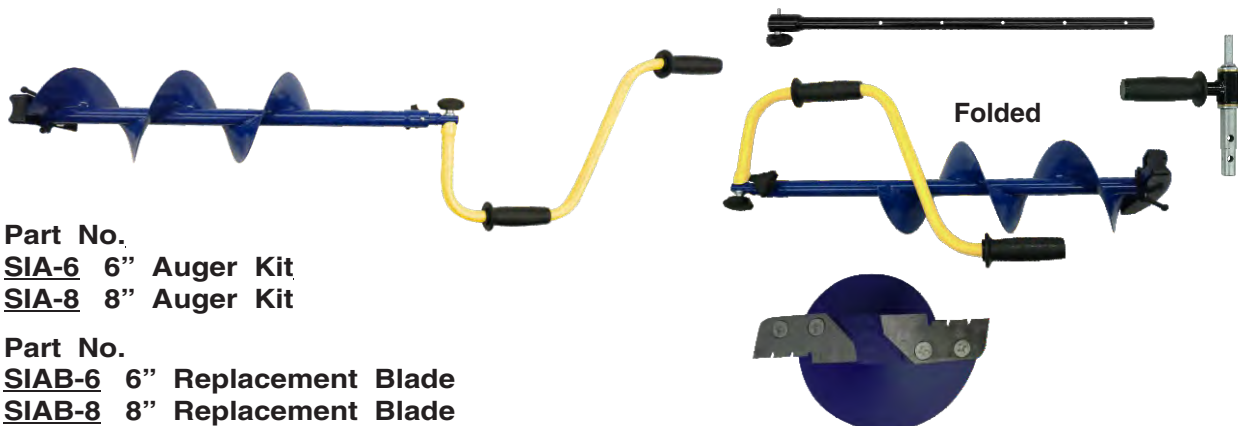

Part No.
SIA-6 6" Auger Kit
SIA-8 8" Auger Kit

Part No.
SIAB-6 6" Replacement Blade
SIAB-8 8" Replacement Blade

SIBERIAN ICE BOX HARDCORE ICE GEAR

- Comfortable padded foam seat
- Compartment below seat contains four storage boxes – one foam lined to secure jigs & hooks (**jigs/hooks not included**)
- Covered secondary tray serves as a tackle box complete with multi-section removable dividers (**tackle not included**)
- Two wire rod holders included
- Easy access all purpose insulated 5 gallon storage compartment for snacks, beverages and live bait
- Clip an aerator on the front slot when using minnows (**aerator not included**)
- Two combo/tip-up organization/storage holders for easy transport (**combos not included**)
- Adjustable padded shoulder strap for comfortable, easy “hands-free” transport
- Serrated foot pads help provide secure, non-slip base

Part No.
SBIX-5

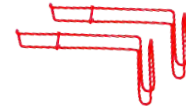

SIBERIAN 3 PC ICE CHISEL HARDCORE ICE GEAR

- Special hardened tiered chipper blade for easy chiseling
- Strong and lightweight with a combined steel and hardened wood shaft
- 54” long 3 piece allows for easy transport and storage
- Includes attached section tightener
- Weighs 6 lbs. 10 oz.

Part No.
SBIC-3

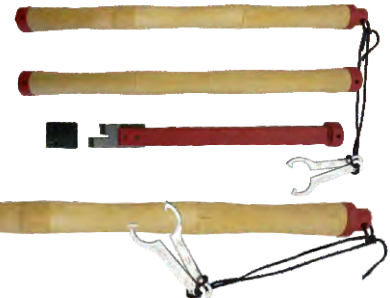

Comes with Carrying Bag

QUICK STRIKE AUTO HOOKSET SYSTEM

- Adjustable hook set rod holder works with most any length of rod combo
- Easily adjusts quickly by using a line/clip system with a special wire trigger that hooks into the rod tip top
- Fully adjustable rod tube
- Light weight and durable
- Comes with an ice anchor which secures the device down if needed

Part No.
QS-10

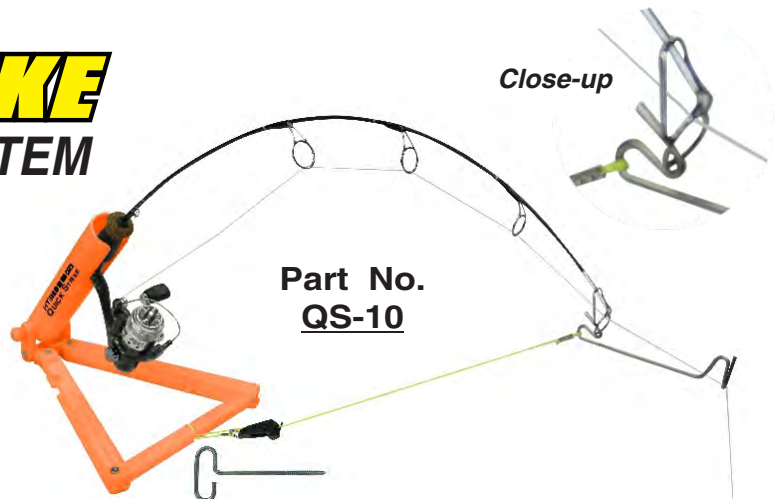

Close-up

Rod Not Included

REVOLUTION EXTREME



- Patented special ergonomic reel seat helps prevent stress and fatigue when fishing for extended periods of time
- Premium custom tapered graphite blanks come in 4 popular actions
- New reel seat allows you to wear a mitt or glove while jigging and reeling
- Ultra-smooth 6 bearing reel with infinite anti-reverse and aluminum spool



Part No:
RVE-25ULSC 25" Ultralight Action **RVE-27MLSC** 27" Medium Light Action
RVE-26LSC 26" Light Action **RVE-28MSC** 28" Medium



REVOLUTION



- Premium custom tapered composite blanks come in 4 popular actions
- Patented special ergonomic reel seat helps prevent stress and fatigue when fishing for extended periods of time
- New reel seat allows you to wear a mitt or glove while jigging and reeling
- Ultra-smooth 3 bearing reel with infinite anti-reverse rigged with line



Part No:
RVS-24ULSC 24" Ultralight Action **RVS-26MLSC** 26" Medium Light Action
RVS-25LSC 25" Light Action **RVS-27MSC** 27" Medium

Platinum Pro DX Series Ice Combo

- Smoothly tapered composite blank provides superb combination of sensitivity, strength and hook setting power
- Comfortable EVA handle with fixed reel seat and cushioned, stainless steel reel seat hood
- Ice resistant aluminum oxide guides
- Comes with PTP-104A four bearing infinite anti-reverse spinning reel with machined aluminum spool and handle



Checker Pattern

NEW LOOK!



Part No.
PTP-24ULSC 24" Ultralight Action
PTP-25MSC 25" Medium Action
PTP-28MLSC 24" Medium/Light Action

FORGE EXTREME DX Ice Combo

- Custom tapered graphite rod blanks come in 4 great actions
- Special ultra-sensitive reel seat design to help detect all bites
- Special green/silver accent colors
- Easy flow no ice up thin low-profile guides
- Premium 4 bearing ultra-light reel with aluminum spool and infinite anti-reverse



Part No.
FEX-24ULSC 24" Ultralight Action
FEX-25MLSC 25" Medium/Light Action
FEX-26LSC 26" Light Action
FEX-27MSC 27" Medium Action



"I've fished a lot of tip-ups over the years, on lakes throughout the ice fishing belt and in just about every conceivable condition. The Polar Tip-up is absolutely the lightest, smoothest, highest quality tip-up I've ever fished, offering the best in performance."

Tom Gruenwald
Author & Pro Fisherman

ORIGINAL
Polar™
TIP-UPS

TIME TESTED & PROVEN !

POLAR TIP-UP FEATURES

- Ultra-smooth, multiple-designed **Trip Shaft** (see Inset "A")
- Guaranteed not to "**FREEZE-UP**" in sub-zero temps
- Frame has unique **V-SHAPE** for easy removal from ice (see Inset "B")
- Unique **LINEGUIDE** designed for easy in and out line placement, yet **LINEGUIDE** holds line in while fishing (see Inset "C")
- "Ends" on frame for fast line pick-up
- The **FLAG WIRE** is on a slight angle so it can be placed on either side of **TRIP SHAFT** for light or heavier "trips" for the use of larger bait
- Three holes in bottom of **REEL** for hooking your hook to keep leaders straight
- Entire unit weighs only 11 3/4 oz. for easy transport
- Polar Tip-Up made of solid, high-impact black or orange plastic material that is **STRONGER THAN WOOD**

**Wind-Free
Trip Wire**

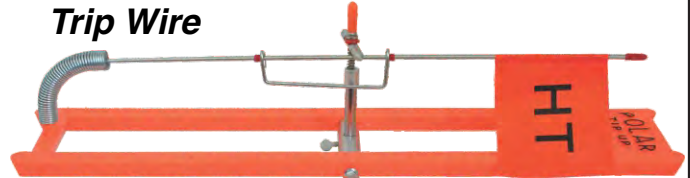

**Ruler Built
in Frame!**

**Guaranteed
Against
Freeze-Up!**

Part No.
PTU-20

Description

Orange Frame,

200' Metal Spool

Regular Flag Wire
Clam Package



**POLAR TIP-UP
SIX-PACK**

Two Each of Three Different Colors

Part No.
PTU-6A



2 each blue frame, 2 each green frame, & 2 each orange frame
200' plastic spool, regular flag wire & wrap-a-round card

**Sell Separately or
Complete Package
UPC Code on Each Tip-Up !**



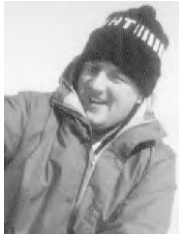

"I've fished a lot of tip-ups over the years, on lakes throughout the ice fishing belt and in just about every conceivable condition. The Polar Tip-up is absolutely the lightest, smoothest, highest quality tip-up I've ever fished, offering the best in performance."

Tom Gruenwald
Author & Pro Fisherman

ORIGINAL

**Polar™
Tip-Ups**

**Guaranteed Against Freeze-Up !
Ruler built in Frame !**

**WIND-FREE
TRIP WIRE**



PTU-2B

black frame,
200' plastic spool
wrap-a-round card

- V-shaped frame with built-in ruler
- Sealed mechanism guaranteed against freeze-up
- Ultra-smooth, multi-tension setting adjustable trip
- Wind-free trip wire with high-vis flag

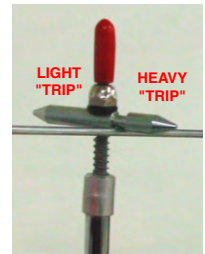

**INSET "A"
TRIP-SHAFT**

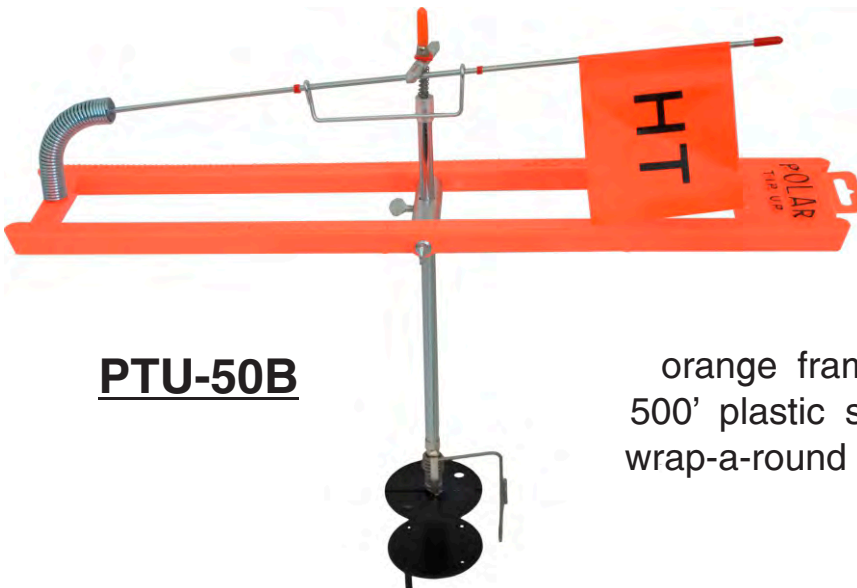

PTU-50B

orange frame,
500' plastic spool
wrap-a-round card



**INSET "C"
LINE GUIDE**

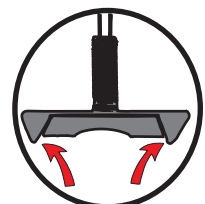

**INSET "B"
V-SHAPED
FRAME**

WIND-FREE TRIP WIRE



**Guaranteed
Against Freeze-Up!**

**Ready To Fish!
Polar Tip-Up
Kits**

Ruler Built In Frame!

PTU-20L



INSET "A"
TRIP-SHAFT



INSET "C"
LINE GUIDE

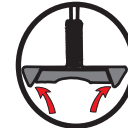

INSET "B"
V-SHAPED FRAME

LIGHTED KIT INCLUDES:

- Orange frame tip-up with 200' spool
- Regular flag wire
- Depthfinder
- Linemarkers
- Linekeeper
- 50 yds of line
- Strike light



**TWO
POLAR
TIP-UPS
PER KIT!**

Polar

"Ready To Fish" Tip-Up Kit

PTB-19K

- 6 gallon pail w/ padded seat
- Pail wire combo / rod holder
- Poly flex ice skimmer
- Minnow scoop
- Depthfinder
- Two spools of black braided tip-up line
- 1/2" tip-up linemarkers
- Two pike/trout rigs w/ treble hook
- Fish mouth spreader

**Two Polar Tip-Ups w/ Black Frame,
Including All the Items Above!**



Ruler Built In Frame!

**ORIGINAL
Polar™
TIP-UPS**

PTU-5



INSET "A"
TRIP-SHAFT



INSET "C"
LINE GUIDE



INSET "B"
V-SHAPED FRAME

KIT INCLUDES:

- Black frame tip-up with 500' spool
- Regular flag wire
- Depthfinder
- Linemarkers
- Linekeeper
- 50 yds of line



POLAR THUNDER TIP-UP

Part No.
PTHR-500



500 Foot
Spool
Capacity



More Trip Tension



Less Trip Tension

- Ultra thin profile for easy storage and transportation
- Trip bar can be adjusted up and down for multiple, light and heavy, trips for when using smaller and larger baits.
- Adjustable telescopic flag wire tension/pressure setting as the telescopic flag wire can be set at different angles to create less or more pressure when set under the trip bar.
- 500' spool with handle
- Easy lock elongated line guide easy to put the line in and out but doesn't come out on its own during use.
- V in frame
- Special thermal tube
- Guaranteed against freeze-up

Polar Tip-Up

Part No.
PTUI-50D

- Ultra smooth trip bar mechanism
- Multiple trip bar settings
- Quick change spool system
- Two spools included, so you can be pre-rigged
- Guaranteed against freeze up
- Has all the trusted polar tip-up quality features you can count on when in the extreme cold elements



**BONUS!
SPOOL**

Includes Two 500' Quick Change Interchangeable Spools

Lady Ice

Polar™ TIP-UP

TIME TESTED & PROVEN !

**Guaranteed
Against Freeze-Up !**

Ruler Built In Frame !

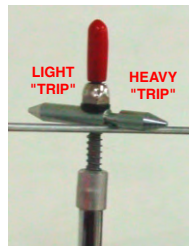

INSET "A"
TRIP-SHAFT



INSET "C"
LINE GUIDE

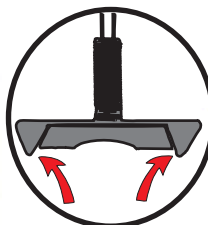

INSET "B"
V-SHAPED FRAME



Part No.
LIP-200

pink frame,
200' plastic spool
regular flag wire
wrap-a-round card

Polar BLUE

Professional Tip-Up

Part No.
PBTU-200
200' plastic spool
w/ line

Part No.
PBTU-500L
500' plastic spool
w/ line

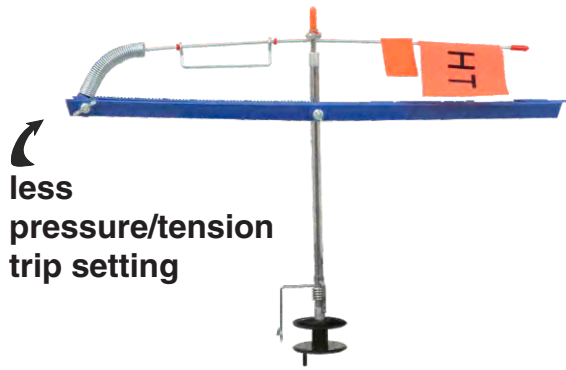

less
pressure/tension
trip setting



more
pressure/tension
trip setting



500' Spool

- All the same advantages, features and benefits of the classic HT polar tip-up
- An adjustable flag spring base that allows user to lighten tension for light-biting fish
- Increase tension when using heavier or larger presentations!
- Like all HT polar family tip-ups, the polar blue professional is guaranteed against freeze-up!

Ice-Man™ Tip-Up

Hook
Holder
Built Into
Frame!

Ruler Built In Frame!



Part No.
ICM-200

200' Spool Bright Yellow Frame

Description

Features include a unique V-Shaped frame, ultra-smooth trip shaft, ruler, and solid, high-impact plastic frame that is "stronger than wood". The flag wire is at an angle to provide heavy and super light trip settings.

ARCTIC ICE XTREME

TIP-UP

Part No.
AIX-200

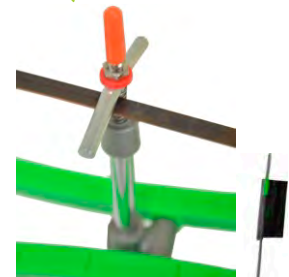

Set Position

- Lubricated for no freeze-up
- Ultra smooth trip system
- Extra high flag for easy viewing
- Folds up for easy storage and transport

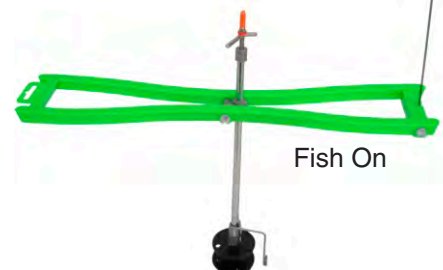

Fish On

HT Premium Arctic Master Wood Tip-Up

- Large capacity spool with bait clip feature
- Hard wood base with multi-coat resin for extra protection from elements
- Ultra glide spool shaft system-for smooth frictionless free spooling performance
- Pre-lubed with exclusive “thermal lube” winter lubricant for friction free performance at any temperature
- Dual trip settings: light for walleye or heavy for larger baits and game fish
- Removable spool shaft for easy cleaning and lubricating
- Extra long 17.5” flag shaft and high visibility flag
- Extra large 200’ line capacity gold metal spool
- Adjustable height adjustment for multiple settings

Part No.
AMT-200

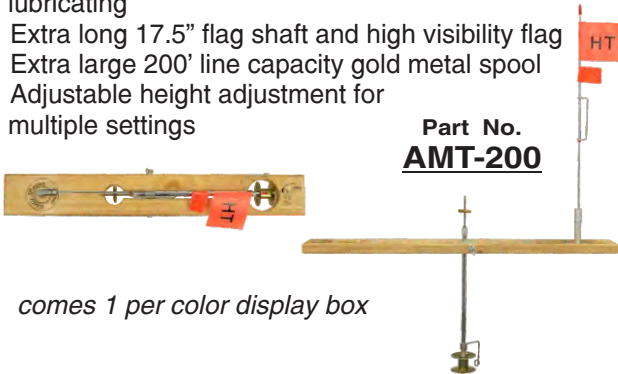

comes 1 per color display box

HUSKY™ Tip-Up “Wind Trip” Free Wire

The HUSKY Tip-Up is a deluxe wooden frame tip-up which features HT’s lifetime guarantee against freeze-up, “easy flow” spools with handle, and an “easy-lock” lineguide for easy set-up. The trip shaft creates two sensitive trip settings. The Husky Tip-Up is designed for the angler who is after the Big Ones.



Part No.
HYT-200

200 ft. Spool

Metal Spool !

PREDATOR TIP-UP

- Super durable “v-shaped” base for easy removal from ice
- Neon green color for high visibility
- Multiple trip settings : light for panfish & heavy for gamefish
- Lubricated with HT **Therma-Lube** ensuring smooth operation in the coldest temperatures
- Special “**Flag Trip Wire**” prevents trips caused by a strong wind or large bait
- 500’ gold metal spool with line

Part No.
PRT-200

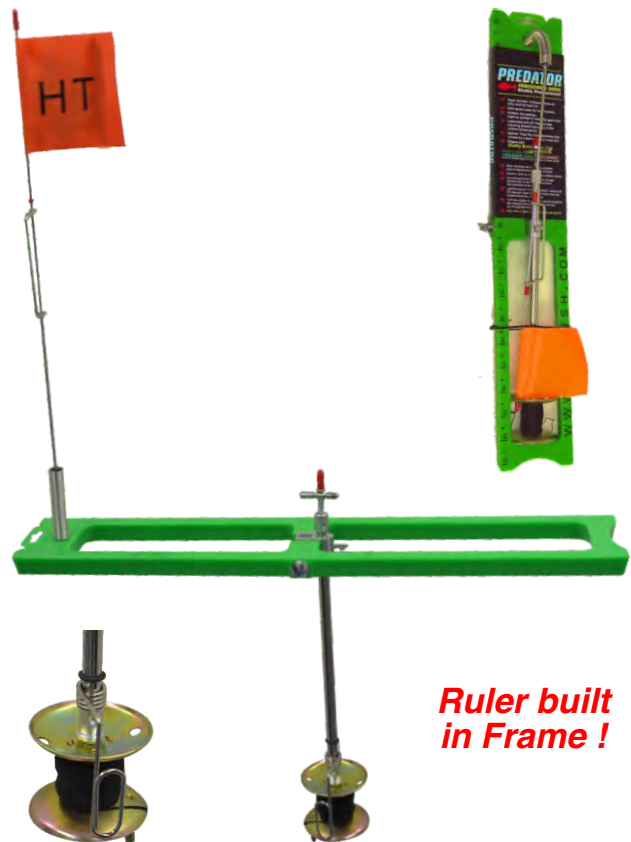

Ruler built in Frame !

PREDATOR PRO **THERMAL TIP-UP**

Fish On !

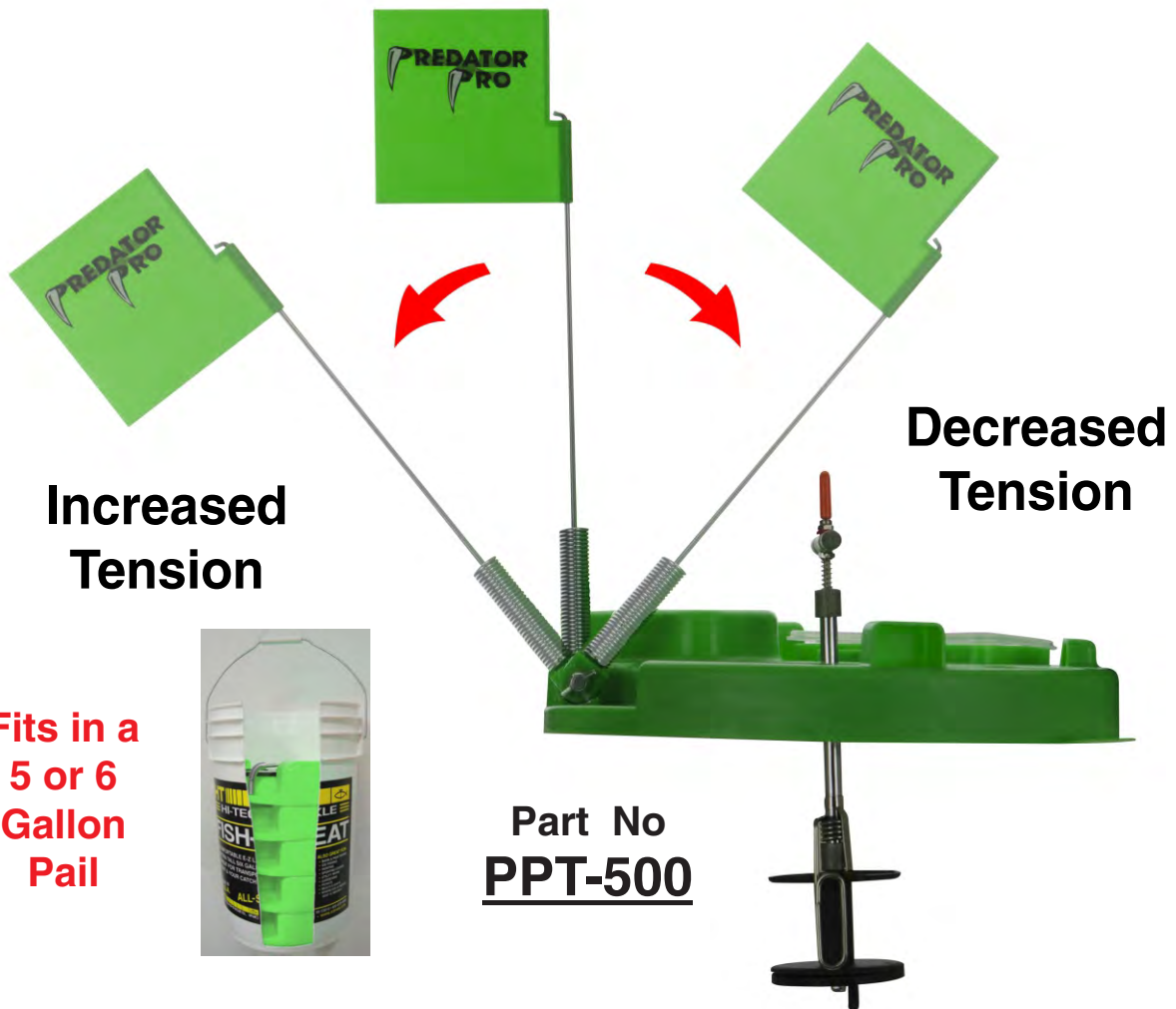

- Mechanism is guaranteed against freeze up and features a multi-setting trip
- Insulated hole cover frame eliminates hole freeze-up and blocks out both blowing snow and light
- Can be stacked in a 5 or 6 gallon bucket for convenient transport or off-season storage
- Unique line guide designed for easy in and out line placement
- Large capacity, 500' spool with hook keeper; built-in three compartment tackle box



Tom Gruenwald
Author & Pro Fisherman

"The Polar Therm Extreme combines versatility and performance. Neither the trip mechanism or hole will freeze under extreme conditions!"

**Guaranteed
Against
Freeze-Up !**

POLAR™ THERM EXTREME TIP-UP



**HANDLE FOR
EASILY LIFTING
TIP-UP FROM HOLE
FOR AN EFFECTIVE
HOOKSET**



200 foot
Spool Capacity

PTE-200

Hi-Viz Orange Frame,
200' Plastic Spool
Telescopic Flag Wire



Fits in a
5 or 6 gal
Pail

**Built-In
Lightstick
Holder**

**For Marking
Your Tip-Up
At Night.**
(Uses UG-7 -
7.5mm x 75mm)

POLAR™ EXTREME TIP-UP

The **POLAR™ THERM EXTREME TIP-UP** is an "underwater" Tip-up designed with many features that put it in a class by itself.

UNIQUE FEATURES of the POLAR THERM EXTREME TIP-UP

FREEZE-PROOF

The EXTREME'S patented trip mechanism is freeze-proof so you'll never have to worry about below-zero temperatures affecting your success again.

CONVENIENT

The EXTREME's design allows the entire tip-up to fit in a 5 or 6 gallon pail. Actually stack over five tip-ups tangle-free in a 6 gallon pail !

TANGLE-PROOF

The EXTREME'S design promotes a tangle-free feature with the foam hook holder at the bottom of the spool.

THERMAL ACTION !

Keeps your ice hole free of ice by trapping the thermal action of the open water. This natural phenomena keeps the ice hole open in sub zero temps !

ADJUSTABLE TENSION TRIP

Set the "adjustable tension" light for panfish, medium for walleye and heavy in deep water for lake trout and northerns.

RUGGED DESIGN

The EXTREME is built rugged out of space age plastic to take punishment while it stays lightweight and warm to the touch.

BUILT-IN TACKLE BOX W/LID

The EXTREME has a built-in tackle box for easily convenient set-up at the hole location.

EASY OPERATION !

Simply pull the center mechanism into a perpendicular position, set line at your selected depth, place flag trip wire under the trip bar, and place tip-up over the hole with the spool under the water.

Polar Extreme 15 Piece Tip-Up Kit

TIP-UP KIT CONTAINS

- 6 Gallon Pail w/ Padded Seat
- Two Polar Therm Extreme Tip-Ups
- Plastic Minnow Scoop
- Minnow Net



- Two Spools of Black Braided Tip-Up Line
- 1/2" Tip-Up Linemarkers
- Two Pike/Trout Rigs with Treble Hook



FTK-15



*Complete Tip-Up
Ice Fishing Kit
with Two Polar
Therm Extreme
Tip-Ups !*

POLAR THERM EXTREME LIGHTED TIP-UP

PTE-500L

bright yellow frame,
500' plastic spool, telescopic
flag wire with 2 led system
night star light !



*500 foot
Spool Capacity*



*with
Light !*

POLAR THERM™ TIP-UP

Polar™ Therm Tip-Ups



PTT-2 MODEL

TIME TESTED & PROVEN
Telescopic Flag!

200' SPOOL W/ HANDLE



200' Spool w/ Handle



500' Spool w/ Handle

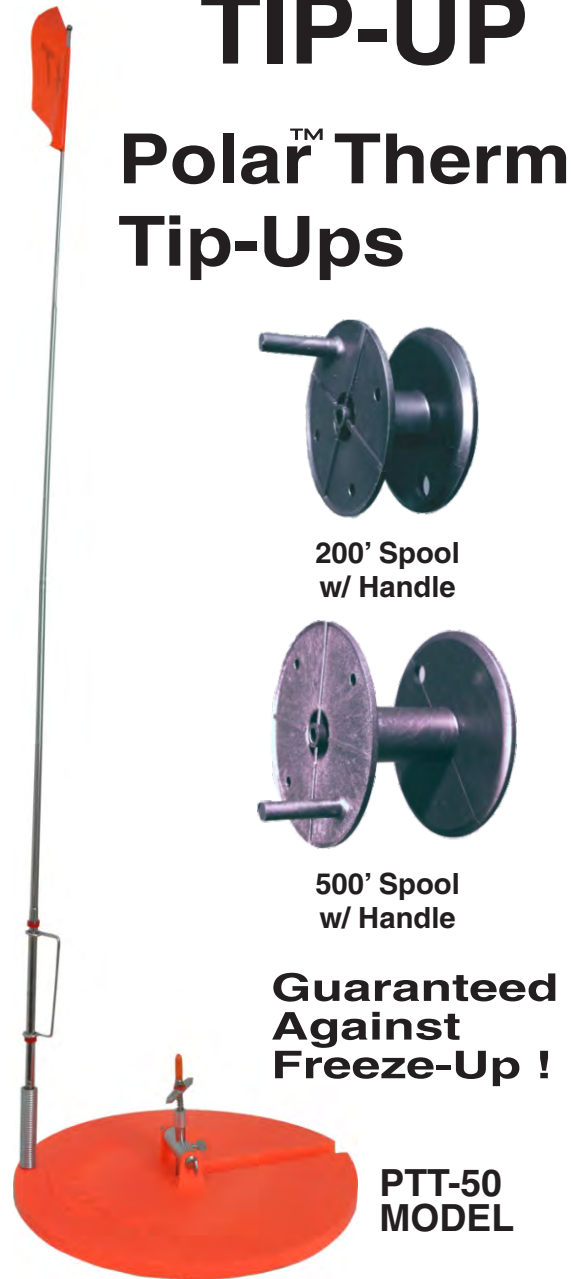

PTT-50 MODEL

500' SPOOL W/ HANDLE

Guaranteed Against Freeze-Up!

The POLAR THERM™ TIP-UP

The POLAR THERM™ TIP-UP is an "underwater" Tip-up designed with many features that put it in a class by itself.

UNIQUE FEATURES of the POLAR THERM™ TIP-UP

- Ultra-smooth, multiple-designed Trip Shaft (see Inset "A")
- Guaranteed lubed shaft to prevent "FREEZE-UP" in sub-zero temps
- Unique LINEGUIDE designed for easy in and out line placement, yet LINEGUIDE holds line in while fishing (see Inset "B")
- Handle on spool to easily retrieve your line
- The FLAG WIRE is on a slight angle so it can be placed on either side of TRIP SHAFT for light or heavier "trips" for the use of larger bait
- Adjustable height settings for different trip shaft settings
- Three holes in bottom of REEL for hooking your hook to keep leaders straight
- Cover works for holes 6" to 10"
- Thermal warming from the open water is trapped by the specially designed cover that seals the hole preventing the hole from icing-up

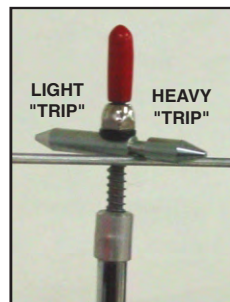

INSET "A" TRIP-SHAFT



INSET "B" LINE GUIDE

Hardwater Tackle

THERMAL TIP-UP

Part No.
HIH-200

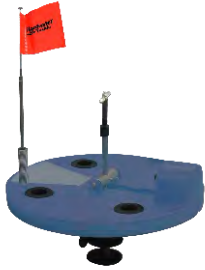

- Insulated frame keeps holes open even in the coldest temperatures
- Adjustable tube mechanism allows varied spool depth and tension trip settings
- Four rod holders imbedded in top of frame organize rods in bucket during transport
- Built-in tackle storage box & tangle free spool shelter alleviates line tangles
- Units stack neatly in 5 or 6 gallon bucket for convenient transport and storage
- Telescopic flag wire w/hi vis signal flag

Hardwater Tackle

TIP-UP WITH LINE

Part No.
HTU-200



- 200' capacity underwater spool w/line
- Lubricated tube mechanism w/multiple setting trip shaft
- Highly visible flag alerts when a fish strikes
- Super durable "v-shaped" base for easy removal from ice

Hardwater Tackle TIP-UP

Part No.
HETU-300L

Wood Stick Frame,
200' Spool Regular Flag
with Line!

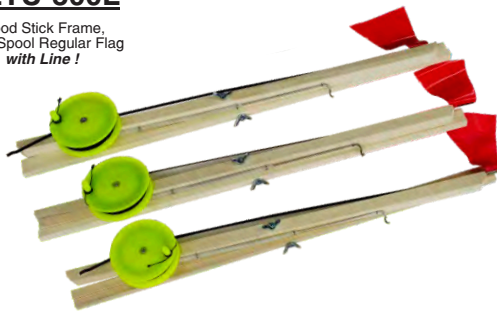

Nordic Ice Tip-Up

Part No.
NTU-3



- 200' capacity underwater spool
- Height adjustable lubricated tube mechanism with multi-tension setting trip shaft
- Protective spool sleeve helps alleviate line tangles and inadvertent hooking
- Built-in hook keeper

Hardwater Tackle TIP-UP

Part No.
HETU-100

Wood Stick Frame,
200' Spool
Regular Flag

Part No.
HETU-100L

Wood Stick Frame,
200' Spool Regular Flag
with Line!



**Ruler Built
In Frame!**

Capture More Than The Wind!

Description

Black Frame,
500' Spool w Drag

NEW! Vinyl Package

Part No.

TU-1



Tom Gruenwald
Author & Pro Fisherman

"This is a great tip-up with many adjustments. When the fishing is tough, the Windlass will come through. It is an extremely sensitive tip-up with a great drag system. The Windlass offers a great multi-jigging system that drives fish to strike!"

The WINDLASS® TIP-UP

The WINDLASS® TIP-UP "jigs" your bait with the slightest "action of the breeze".

UNIQUE FEATURES of the WINDLASS®

- V-shaped frame for easy removal from ice
- "Ends" on frame for quick line pick-up
- Tip-Up "folds down" for easy storage and transport
- Made of solid, high impact black plastic material that is STRONGER THAN WOOD
- Unique Spring-Adjustment Bracket for different weighted lures (see INSET "A")
- New DRAG feature on Spool for different tension settings (see INSET "B")



HT Electronic MAGNUM POLAR Pop-Up

- Has a light/buzzer bite indicator for night fishing which can be turned off during the day
- When fish is running the light and buzzer pulsate
- Batteries not included (2 aa)
- Built in hole cover with velcro door so you can see if the fish is running or not
- Neon orange handle on spool so you can tell if the spool is turning when a fish is on
- Extra large capacity spool with handle that holds 1500 feet of braided line
- Adjustable spring tension drag system
- Comes with two 3 mm x 39 mm light sticks (part no. UG-4)

Part No.

PPM-1500LB





"The list of features for the Polar Pop-Up is virtually endless! It's the easy operation, positive strike signal, adjustable spool tension and super smooth, freeze-proof, wind-proof, snow-proof magnetic trip features that are supreme. This unique specialty tip-up has all the qualities to help improve anyone's on-ice catch."

Tom Gruenwald
Author & Pro Fisherman

Part No.
PP-2L

Hand Tested !
Guaranteed to be Waterproof !

The Original Magnetic Polar Pop-Up Tip-Up with New Deluxe Lighting System

THE ORIGINAL MAGNETIC POP-UP

Comes with Two 3 mm x 39 mm Light Sticks!

Clam Shell Packaging!



POLAR™ POP-UP TIP-UP

The POLAR POP-UP TIP-UP is an "underwater" Tip-up designed with many features that put it in a class by itself.

UNIQUE FEATURES of the POLAR POP-UP TIP-UP

FREEZE-PROOF

The POP-UP's patented magnetic trip mechanism is freeze-proof so you'll never have to worry about below-zero temperatures affecting your success again.

WIND-PROOF

There is no exposed line or trip mechanism. Even a 50 mph wind can't trip the POP-UP accidentally because its sturdy 3-point suspension makes it stay put.

SNOW-PROOF

Drifting snow simply can't plug the POP-UP's trip mechanism because of its unique design.

POSITIVE SIGNAL

There's no exposed flag to confuse you from a distance and the flag shaft is a bright fluorescent orange so you get a positive signal when a fish strikes.

ADJUSTABLE TENSION

Set the "adjustable tension" light for panfish, medium for walleye and heavy in deep water for lake trout and northerns.

SPOOL WINDER

The POP-UP's specially designed spool winder lets you wind up your line easily any time you want.

WATER BRAKE

On hard strikes, the spool winder acts as a water brake to keep the spool from over-running and fouling up your line.

SPOOL LOCK

The easy-to-grip knurled spool lock is designed for adjusting tension and for locking the spool when storing.

RUGGED DESIGN

The POP-UP is built rugged out of space age plastic to take punishment while it stays lightweight and warm to the touch.

EASY OPERATION !

Simply unlock the cap, open the legs, unlock the spool and bait up ! That's all there is to it. And packing up is just as easy.

MAGNUM POLAR POP-UP HOLE COVER TIP-UP

- Extra-large 1,500' spool with handle
- Adjustable magnet tension settings
- Adjustable positive drag system
- Special reflective top for easy visibility when tube is set down in the "set position" or when it is up in the "bite position"
- New rubber line keeper ring that slides up and down on the pop up tube above the spool so you can put your hook in it to keep your leaders always straight
- Comes with Two 3 mm x 39 mm Light Sticks

Part No.
PPM-1500

1500 Foot
Spool Capacity



The Original ICE RIGGER

Part No
IRG-1

The Original Ice Rigger allows you to fish with multiple rod & reel combos at one time! The Ice Rigger acts like a traditional tip-up with a flag that signals the strike. Simply lift the rod out of the holder and fight your fish.

Set Position

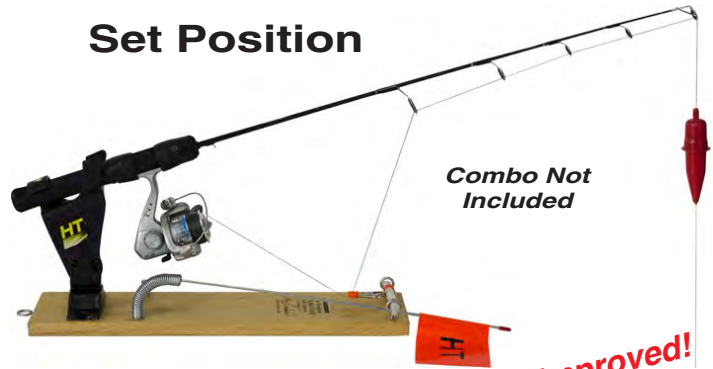

*New and Improved!
Adjustable Rod Holder*

Fish On



HOOKMASTER

Sure Hook Hookset System

- Multiple Tension settings based on the action of your combo and length
- Multiple angle settings with the adjustable rod combo holder
- Comes with a flag indicator system. Easily clips onto any diameter of rod
- Never miss a fish again with this sure hook system
- Folds up for easy transport and storage

Part No
HMH-1

Combo Not Included

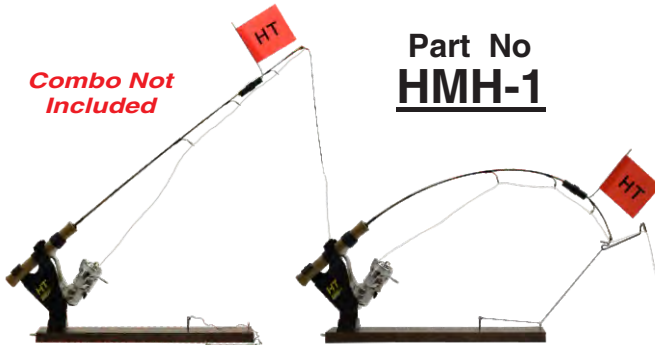

Fish On Position

Set-Up Position

HT STRIKER PRO

Hookset System

- Universally works with virtually any length or action ice combo
- Sturdy yet lightweight aluminum construction
- Adjustable strike-trip tension settings
- Comes with two trigger loops with sponge floats

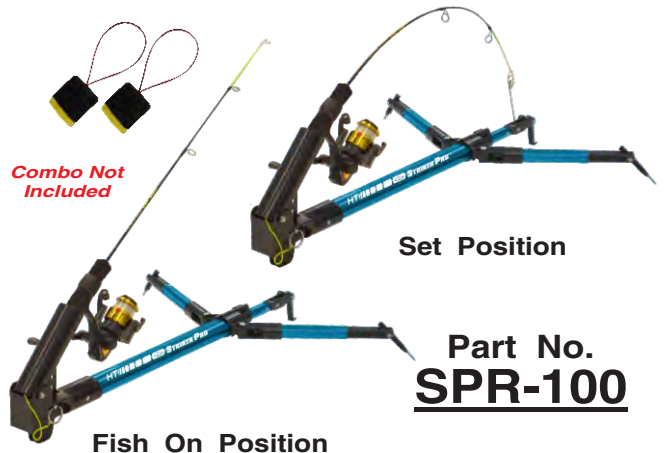

Set Position

Part No.
SPR-100

Fish On Position

MAMMOTH PRO TIP-UP



Deluxe hardwood, high profile underwater tip-up. Hardwood frame features an extra long, 31" body and an adjustable height flag steel that extends 19" above the top of the body a full three feet above the frame when fully extended. Ultra-sensitive trip system is attached to an underwater 1500' large arbor spool and lubed tube assembly for super-fast line retrieval and super-smooth operation in even the coldest winter weather.

Part No.
MTP-500

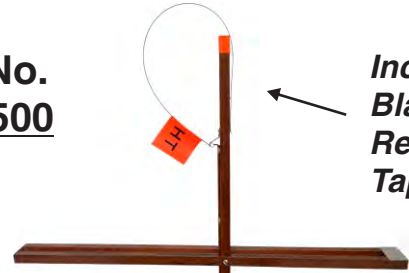

Includes:
Blaze Reflector Tape

- Heavy duty hardwood frame
- 31" high center body & 19" spring steel flag
- Hi-Viz signal flag rises over 3 feet above the ice
- Rigged with 50 yards of 20# test braided line
- Ultra-sensitive trip system w/ deluxe lubed tube for smooth operation in the coldest weather
- Super smooth 1500' capacity large arbor spool
- Large spool for fast line retrieval
- Folds neatly for easy transport and storage



MAINE TRAP™ TIP-UP

- Extra high flag
- Deluxe wooden frame
- Sure-grip tension drag
- Slim line & lightweight for easy transporting
- Easy set-up and take down
- Trip mechanism eliminates wind trips

Part No.
MT-1
500' Spool

FRONTIER™ TIP-UP

Part No.
FRT-1
1500' Spool

- Extra high flag
- Deluxe wooden frame
- Sure-grip tension drag
- Slim line & lightweight for easy transporting
- Easy set-up and take down
- Trip mechanism eliminates wind trips

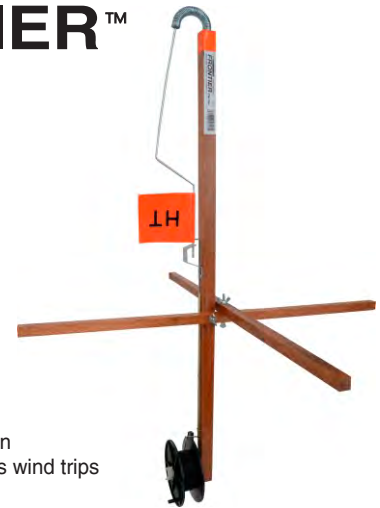

FISHERMAN™ TIP-UP with Reel Drag

- 8" grease-filled tube for Trip-Shaft to prevent freeze-up
- Extra-high Flag for better visibility
- Tip-Up and Spool are made of solid, high-impact black plastic material that has proven to be **STRONGER THAN WOOD**

Part No.
ETU-2



200' Spool w/drag



FISHERMAN™ TIP-UP with Reel Drag

- 1500' spool w/ drag
- 8" grease-filled tube for Trip-Shaft to prevent freeze-up
- Extra-high flag for better visibility
- Tip-Up and Spool are made of solid, high-impact orange plastic material that has proven to be **STRONGER THAN WOOD**

Part No.
ETU-10

1500' Spool w/drag



EXPLORER MAGNUM TIP-UP

- “Ultra-smooth” trip mechanism
- Super high flag for easy visibility
- Deluxe traditional wood frame - **dual rail design**
- Metal “easy flow” spool - 500 foot capacity
- Folds for easy transporting
- Rigged with 50 yards of 20# test braided line

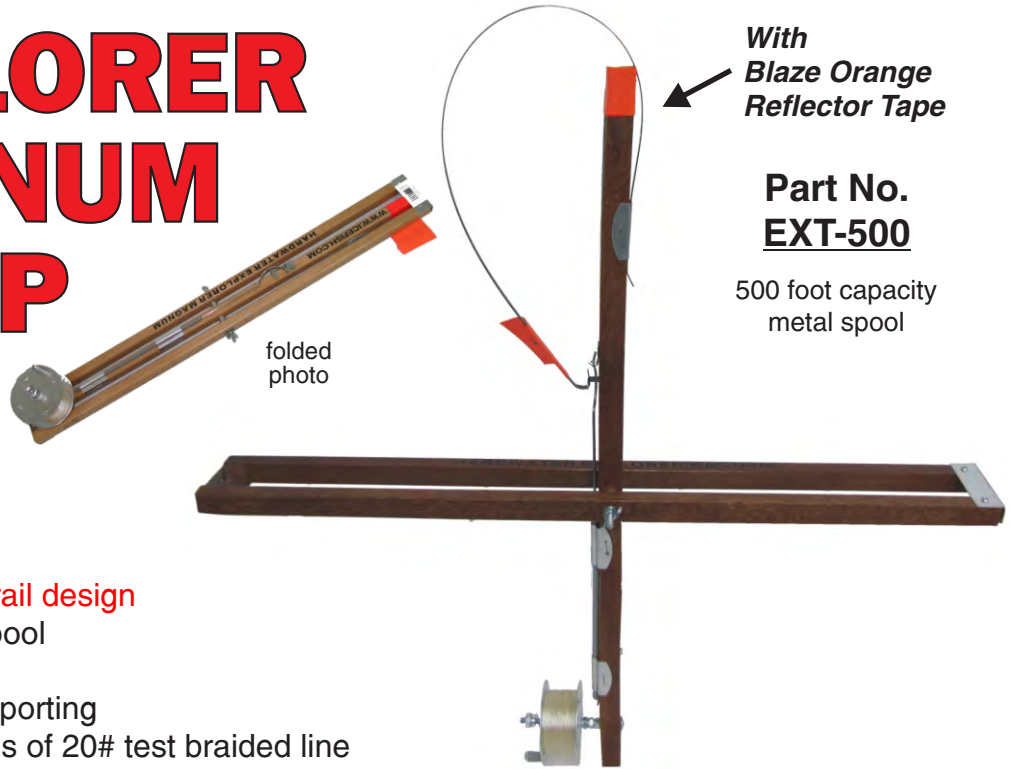

EXPLORER TIP-UPS

Part No. **EX-200**
200 foot capacity metal spool

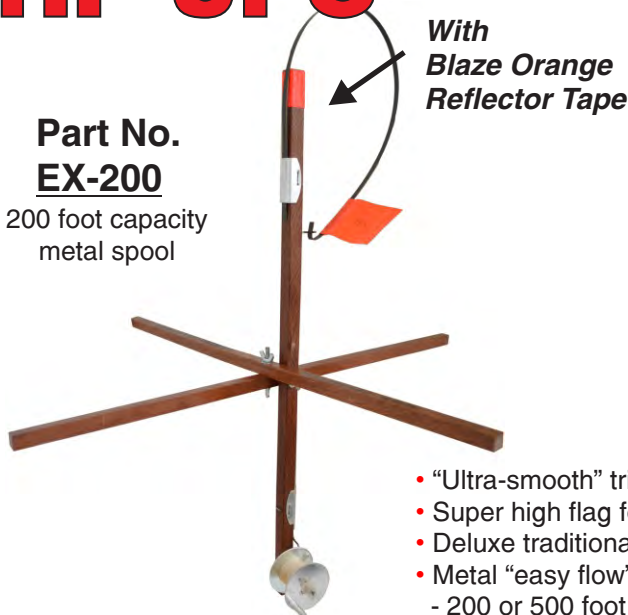

Ruler built in Frame !

With Blaze Orange Reflector Tape

Part No. **EXP-500**
500 foot capacity metal spool

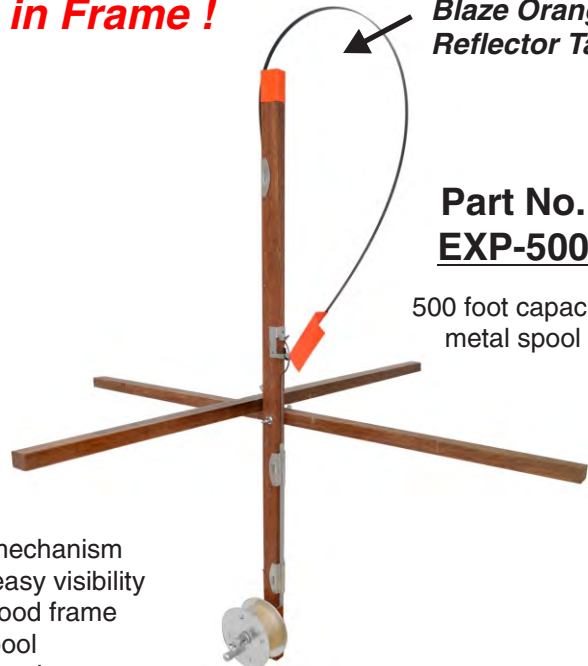

- “Ultra-smooth” trip mechanism
- Super high flag for easy visibility
- Deluxe traditional wood frame
- Metal “easy flow” spool - 200 or 500 foot capacity
- Folds for easy transporting
- Rigged with 50 yards of 20# test braided line

Little Jigger 2 IN 1 TIP-DOWN

- Works with traditional jig poles or combos
- Strong and durable base
- Folds up or down for easy transport and storage
- Multiple locking angle settings on base to create different settings for your jig pole or rod combo

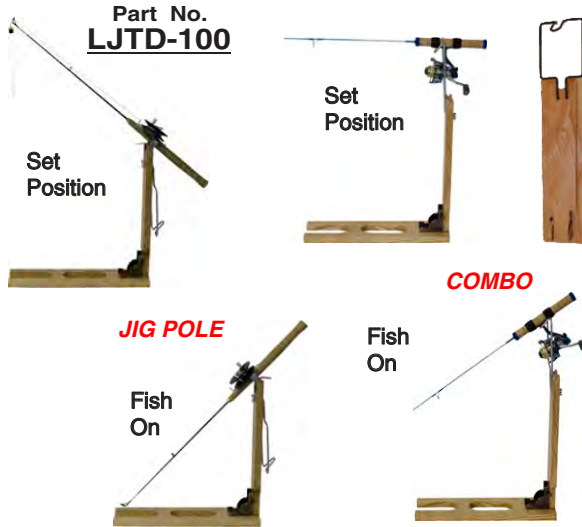

IceMaster Ultimate Tip Down

Part No.
BTD-50

- Unfold, lock, and position the tip down next to your ice hole
- Set your line as if you were ready to fish and place the combo on top of the tip down.
- When the fish bites, the tip of your rod will pull down signaling the bite.
- The combo is easily lifted from the tip down to fight the fish.
- Designed to work with jig poles with a balance rod.
- Folds flat for easy transport
- Stands high for easy operation!

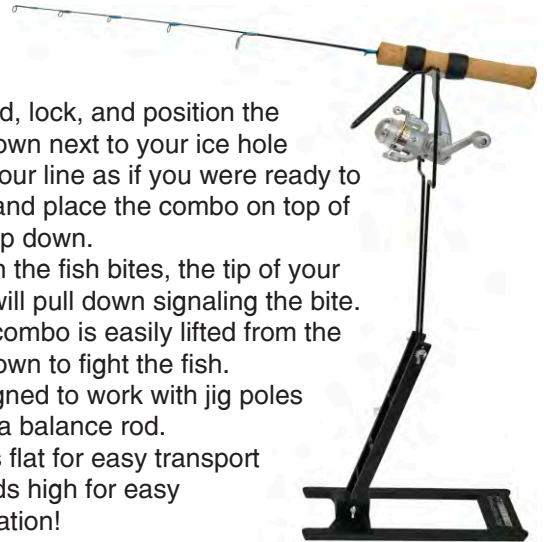

12v/dc car power adapter
& battery clamps included
batteries not included

Oxy-Max Air Pump

Part No.
AP-2102A

voltage: 3v
high speed
operates w/
batteries

Solar Powered Oxy-Max Air Pump



batteries not included

Part No.
OSPA-1

voltage: 2.4v
two speed
operates w/
batteries



batteries not included

Oxy-Max Air Pump

Part No.
AP-2102

voltage: 3v
high speed
operates w/
batteries



batteries not included

Oxy-Max Air Pump

Part No.
AP-3102

voltage: 1.5v
two speed
operates w/
batteries

NERO RUSSIAN HAND AUGER KIT

Award winning ice augers made of Russian steel of unmatched quality that cuts ice with amazing ease!

Give us a call at
800-216-5184

Watch Online

Nero Ice Auger Action Video
<https://youtu.be/U0EZq3hcOb4>

65G steel Nero blades feature a razor sharp, heat treated cutting edge engineered to slice through any type of ice with unprecedented precision and speed, creating the smoothest, fastest cutting ice auger in the world

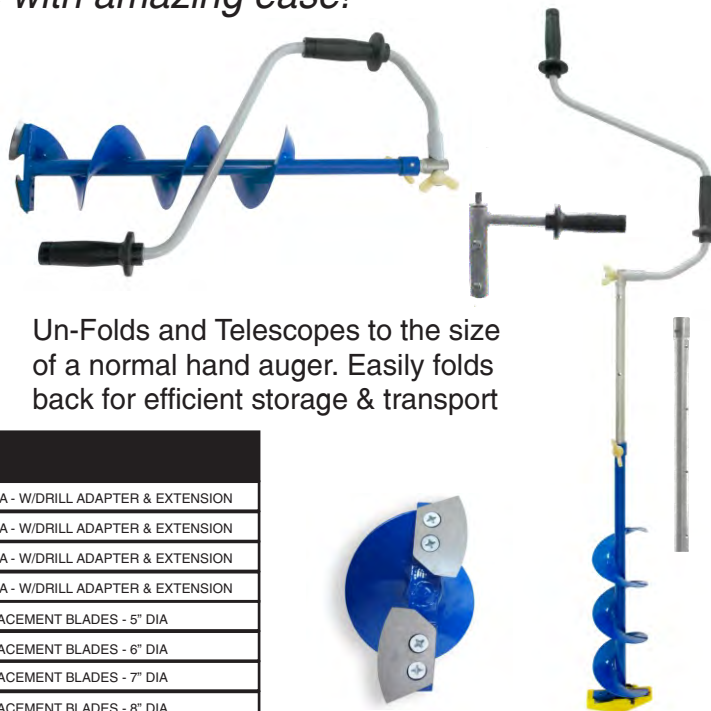

Un-Folds and Telescopes to the size of a normal hand auger. Easily folds back for efficient storage & transport

Part Number	Description
MNAK-5	MINI NERO TELESCOPIC RUSSIAN HAND AUGER - 5" DIA - W/DRILL ADAPTER & EXTENSION
MNAK-6	MINI NERO TELESCOPIC RUSSIAN HAND AUGER - 6" DIA - W/DRILL ADAPTER & EXTENSION
MNAK-7	MINI NERO TELESCOPIC RUSSIAN HAND AUGER - 7" DIA - W/DRILL ADAPTER & EXTENSION
MNAK-8	MINI NERO TELESCOPIC RUSSIAN HAND AUGER - 8" DIA - W/DRILL ADAPTER & EXTENSION
MNAB-5	MINI NERO TELESCOPIC RUSSIAN HAND AUGER REPLACEMENT BLADES - 5" DIA
MNAB-6	MINI NERO TELESCOPIC RUSSIAN HAND AUGER REPLACEMENT BLADES - 6" DIA
MNAB-7	MINI NERO TELESCOPIC RUSSIAN HAND AUGER REPLACEMENT BLADES - 7" DIA
MNAB-8	MINI NERO TELESCOPIC RUSSIAN HAND AUGER REPLACEMENT BLADES - 8" DIA

HT ARCTIC EXPRESS ICE AUGER

"NEW and Improved"

Features

- Custom blade "lightning fast" design
- Precision ground stainless steel blades
- Two piece for easy transport
- Three different height adjustment settings



Part No. **AE-6**
6" Dia.
Part No. **AE-7**
7" Dia.
Part No. **AE-8**
8" Dia.

Black Auger Handle Replacement Blades

Part No. **AB-6D** 6" Blade
Part No. **AB-7D** 7" Blade
Part No. **AB-8D** 8" Blade

Arctic Express™ Ice Auger Replacement Blades

Specially designed for the HT Arctic Express Ice Auger. Razor sharp, annealed treated cutting blades. 1 pair per pack



HT PREMIUM E-DRILL

NYLON HAND AUGER KIT

PROVIDES UNSURPASSED STABILITY AND SUPERIOR CUTTING PERFORMANCE!

Features

- 33" shaft with lightweight yet durable synthetic nylon flighting
- Razor sharp steel blades & custom designed center ring system for increased stability and smoother cutting
- Universal drill adapter with 14" extension
- Safety cover and strap included



Part No. EDK-6 6" KIT

Part No. EDK-8 8" KIT

E-Drill Replacement Blades

Part No. EDRB-6 6" Blade

Part No. EDRB-8 8" Blade

14" Drill Adapter

HT POLAR EXPRESS ICE AUGER

Features

- Precision ground stainless steel blades
- Two piece for easy transport
- Three different height adjustment settings

Part No. PA-6
6" Dia.

Part No. PA-7
7" Dia.

Part No. PA-8
8" Dia.



"NEW and Improved"

Black Auger Handle Replacement Blades

Part No. PRB-6D 6" Blade

Part No. PRB-7D 7" Blade

Part No. PRB-8D 8" Blade

POLAR™

Ice Auger Replacement Blades

Specially designed for the HT POLAR Ice Auger. Razor sharp, annealed treated cutting blades.

1 pair per pack

POLAR ESCAPE PRO

20" Bucket Chisel with Hammer



Part No. PEBC-20

64" 2 Piece Chisel with Rubber Coated Handle for a Sure Grip



Part No. PEPIC-2

POLAR ICE CHISEL

Part No. HTIC-1

one piece
54" with 5/8" rebar



Part No. HTIC-2

two piece
54" with 5/8" rebar



HT PREMIUM E-DRILL PRO DX

CORDLESS DRILL ADAPTER

CONVERTS ANY MANUAL AUGER INTO A POWER AUGER!

Part No.
EDXA-1



Features

- 13.75" Three Setting Solid Steel Auger Extension
- Built-In Cordless Drill Adapter with Comfortable Ergonomic Hand Grip
- 1/2" Extension Head Fits Securely into Drill Chuck
- Adjustable "U Shaped" Bracket for Drill Stabilization
- Fits Most Major Cordless Drill Brands

Power Ice AUGER ADAPTER SHAFT

Part No.
PIA-12

- 12 inches long makes drilling through the ice much easier
- Dependable solid steel shaft
- Three adjustable height positions to accommodate different ice thicknesses
- **New and improved 7/16 inch hex**

"NEW and Improved"
Converts your Hand Ice Auger into an Electric Power Auger



HT POLAR SHOVEL

Part No.
PSV-1

- Super strong poly flex scoop
- Sure grip EVA contoured foam handle
- Extra large handle for easy shoveling with mitts or gloves
- Telescopic handle for easy transport and storage
- Super rigid handle for ultimate strength



CORDLESS DRILL ADAPTER CONVERTS ANY MANUAL AUGER INTO A POWER AUGER!

Part No.
NAXT-1

Features

- 14" three setting solid steel auger extension
- Built-in cordless drill adapter with comfortable ergonomic hand grip
- Hexagonal extension head fits securely into drill chuck
- Fits all major cordless drill brands

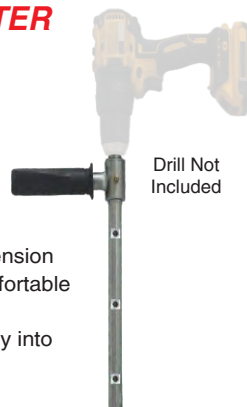

Polar

Electric Ice Drill Adapter

Part No.
PDA-1

ALLOWS CONVERSION OF MANUAL ICE AUGERS INTO POWER MODELS BY ALLOWING ATTACHMENT OF A CORDLESS POWER DRILL!

- 1/2" hexagonal adapter
- Fits 4", 5", 6", 7" and 8" diameter models
- Virtually indestructible – solid hardened steel machined body
- Fits most ice auger brands



w/ Corner Reflectors

27" High in Folded Position

Polar Escape™ TWO MAN

Features

- Durable sled base with built-in runners for easy transporting
- Hi-tech pull-over design for easy set-up
- Special heavy duty heat absorbing material
- 4-way velcro draped window system
- Easily collapses to fit into a car trunk
- Accommodates four fishing holes for two people
- Two swivel chairs and tow rope

PREBOOK ONLY



Includes Travel Cover!



Folded Position

SPECIFICATIONS

MODEL #	WEIGHT	CASE SIZE	CASE QTY	SET-UP SIZE	MATERIAL SPECS	ACCESSORIES
PEF-2	85#	65" X 22" X 10"	1	92"L X 67"W X 65"H	600 DENIER - POLYESTER	TWO CHAIRS & COVER!

Polar Escape™ ONE MAN

Features

- Durable sled base with built-in runners for easy transporting
- Hi-tech pull-over design for easy set-up
- Heavy duty heat absorbing 500 denier material
- 4-way velcro draped window system
- Easily collapses to fit into a car trunk
- Accommodates two fishing holes for one person
- One swivel chair and tow rope

PREBOOK ONLY

w/ Corner Reflectors



Includes Travel Cover!



Windbreak Position



Folded Position



SPECIFICATIONS

MODEL #	WEIGHT	CASE SIZE	CASE QTY	SET-UP SIZE	ADDITIONAL INFO
PEF-1	51#	46" X 34" X 7"	1	90"L X 33"W X 54"H	Includes Shelter Cover & Chair

Polar Escape™ PRO

2-PERSON
ICE SHELTER



Features

- Sets-up in minutes
- Strong metal hubs to withstand cold temperatures
- 1-door for easy in and easy out access
- All way window system for looking out
- Anchor ropes and anchors included

PREBOOK ONLY

SPECIFICATIONS

MODEL #	CAPACITY	HUB TO HUB SIZE	SET-UP SIZE	MATERIAL SPECS
PP-2	2-PERSON	76" X 76"	59"L X 59"W X 67"H	300 DENIER COATED

Polar Escape™ PRO

3-PERSON
ICE SHELTER



Features

- Sets-up in minutes
- Strong metal hubs to withstand cold temperatures
- 1-door for easy in and easy out access
- All way window system for looking out
- Anchor ropes and anchors included

PREBOOK ONLY

SPECIFICATIONS

MODEL #	CAPACITY	HUB TO HUB SIZE	SET-UP SIZE	MATERIAL SPECS
PP-3	3-PERSON	90" X 90"	70"L X 70"W X 78"H	300 DENIER COATED
PP-3XW	3-PERSON	80" X 80"	59"L X 59"W X 65"H	300 DENIER COATED
PPE-3XW	3-PERSON	80" X 80"	59"L X 59"W X 65"H	300 DENIER COATED

Fishing Area (Footprint) 75" x 75"

Polar Escape™ PRO

4-PERSON
ICE SHELTER

Two Door Access!



Features

- Sets-up in minutes
- Strong metal hubs to withstand cold temperatures
- E-Z in/out 2-door system
- All way window system for looking out
- Anchor ropes and anchors included

PREBOOK ONLY

SPECIFICATIONS

MODEL #	CAPACITY	HUB TO HUB SIZE	SET-UP SIZE	MATERIAL SPECS
PP-4XW	4-PERSON	99" X 99"	70"L X 70"W X 78"H	300 DENIER COATED

Fishing Area (Footprint) 90" x 90"

Polar Escape™

Explorer

4-PERSON
ICE SHELTER

Two Door Access!



Features

- Sets-up in minutes
- Strong metal hubs to withstand cold temperatures
- E-Z in/out 2-door system
- All way window system for looking out
- Anchor ropes and anchors included

PREBOOK ONLY

SPECIFICATIONS

MODEL #	CAPACITY	HUB TO HUB SIZE	SET-UP SIZE	MATERIAL SPECS
PPE-4XW	4-PERSON	99" X 99"	70"L X 70"W X 78"H	300 DENIER COATED

Fishing Area (Footprint) 90" x 90"

XW = Extra Wide Base E = Insulated

Polar Escape™ PRO

5-7 PERSON
ICE SHELTER

Two Door
Access!



Features

- Sets-up in minutes
- Strong metal hubs to withstand cold temperatures
- E-Z in/out 2-door system
- All way window system for looking out
- Anchor ropes and anchors included

PREBOOK ONLY

SPECIFICATIONS

MODEL #	CAPACITY	HUB TO HUB SIZE	SET-UP SIZE	MATERIAL SPECS
PP-57	5-7 PERSON	143" X 143"	66"L X 66"W X 78"H	300 DENIER COATED
PPE-57	5-7 PERSON	130" X 130"	66"L X 66"W X 85"H	300 DENIER COATED

Polar Escape™ PRO

5-7 PERSON
ICE SHELTER

Two Door
Access!



Features

- Sets-up in minutes
- Strong metal hubs to withstand cold temperatures
- E-Z in/out 2-door system
- All way window system for looking out
- Anchor ropes and anchors included

PREBOOK ONLY

SPECIFICATIONS

MODEL #	CAPACITY	HUB TO HUB SIZE	SET-UP SIZE	MATERIAL SPECS
PP-57XW	5-7 PERSON	143" X 143"	66"L X 66"W X 78"H	300 DENIER COATED
PPE-57XW	5-7 PERSON	131" X 131"	60"L X 60"W X 80"H	300 DENIER COATED

Fishing Area (Footprint) 80" x 80"

Polar Escape™ PRO

6-PERSON
ICE SHELTER

Two Door
Access!



Features

- Sets-up in minutes
- Strong metal hubs to withstand cold temperatures
- E-Z in/out 2-door system
- All way window system for looking out
- Anchor ropes and anchors included

PREBOOK ONLY

SPECIFICATIONS

MODEL #	CAPACITY	HUB TO HUB SIZE	SET-UP SIZE	MATERIAL SPECS
PP-6	6-PERSON	160" X 90"	138"L X 70"W X 79"H	300 DENIER COATED

Polar Escape™ PRO SHELTER KIT

Kit Includes Part No. **PP-2K**

- One 2-person polar escape shelter
- One sled travel cover
- One sled with tow rope
- Two folding 3-leg sports chairs

PREBOOK ONLY



Shelter Specifications

Set-Up Size: 59" L X 59" W X 67" H

Sled Size: 47" Long X 23" Wide X 8" Deep

Part No. **PRH-1**



Shelter Not Included

Arctic Bay SHELTER HITCH

The Polar Escape Shelter Hitch is designed to work with the Polar Escape Shelters. The design also makes this hitch excellent for just about any type of towing application. Easily and securely attaches to almost any type of sled or cart. Use with a snowmobile, ATV, Garden Tractor, etc.

Quik Shak ICE SHELTER



- Super compact one man shelter
 - Sets up in seconds
 - Comfortable seat is part of the shelter
- PREBOOK ONLY**

SPECIFICATIONS

MODEL #	WEIGHT	CASE SIZE	CASE QTY
QH-1	29#	52" X 33" X 5"	1

SET-UP SIZE	MATERIAL SPECS	DESCRIPTION
45" L X 28" W X 62" H	300 DENIER - POLYESTER	ONE MAN ICE SHELTER

Polar Escape™ SHELTER COVER

Part No.
PEFC-2

1 per Case



- Designed specifically for the PEF-2 shelter
- Protects your gear
- Great for off-season storage

Polar Escape™ SHELTER COVER

Part No.
PEFC-1

1 per Case



- Designed specifically for the PEF-1 shelter
- Protects your gear
- Great for off-season storage



Light & Fan Indoor / Outdoor

Part No.
SL-10F

- Handy hook hangs anywhere
- 2 speed fan
- Ultra-bright LED light
- Light tilts to direct light
- Operates on 2 "D" batteries
- Batteries not included

POLAR™ Snow Sled

Minimum Order
6 each

*Tow Rope
Included*

Features

- Rugged polyethylene unit is virtually indestructible
- Deep sides easily haul your equipment including augers
- Special "custom-hull" glides over the snow instead of pushing or plowing the snow
- Easy pulling & transport

Part No.
PES-1

20"W x 42"L
x 8" Deep

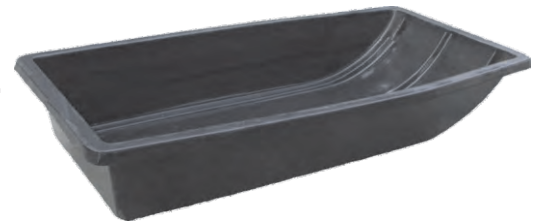

POLAR SHELTER LIGHT

Part No.
PPL-24



- Superior 24 cree led's for the ultimate brightness
- Magnet on back to attach to steel pipes in shelters, etc.
- Hanger hook to easily use in all situations
- Uses 3 AAA batteries - not included

SHELTER SAFETY LIGHT

NEW with REMOTE CONTROL

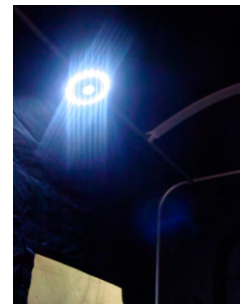

Part No. SL-10

This Super Bright L.E.D. Light is great where a portable light source is needed. Designed to attach to steel with two strong magnets, hang from a lanyard, or attach to anything with Velcro®.

Uses 4 AA batteries
that are not included

POLAR ESCAPE™ SHELTER "T" ANCHOR

Part No.
TA-1
1 per pkg

Part No.
TA-2
2 per pkg

The Polar Escape Shelter "T" Anchor is designed to work with any shelter. The "T" head of the anchor is coated with a soft rubber coating that is warm to the touch. The aggressive thread digs into the ice quickly and holds firm.



ARCTIC BAY ICE ANCHOR POWER DRIVE

Part No.
IAPT-1

- Designed to quickly and easily screw shelter anchors into the ice
- Use with any 18 volt or larger re-chargeable hand drill.
- Universally works with most "T" type ice anchor or top oval loop style ice anchor.



SHELTER ANCHORS

HT's SHELTER ANCHOR drives deep into the ice to secure even the loftiest portable shelter.

Part No.
SA-2
2 per pkg

Part No.
SA-4
4 per pkg



ANCHOR ICE TOOL

Part No.
AIT-1

- Works for all styles of ice anchors
- Use in your favorite 18 volt rechargeable drill on the ice to quickly screw in your ice anchors to secure your ice shelter
- Strong steel receiver shaft that goes into the drill chuck is unbreakable
- Makes ice fishing more enjoyable to help get your ice shelter secure so you can get out of the harsh elements



Hardwater Tackle

BUCKET SEAT



Part No.
HBS-100

- Universally fits any five or six gallon pail
- Durable, built-in rod holder clips to organize & secure ice rods or combos during transport or storage
- Super comfortable, extra thick padded foam seat

Bucket and Rods
Not Included

Bucket Fish Bag



Part No.
BFB-100

*Bucket
and Rods
Not Included*

- Keep your bucket clean from fish slime
- Deposit fish into the fish bag while you fish
- Simple metal frame with fish bag that clips in for use
- E-Z velcro close top system when finished fishing
- Once fish bag is un-clipped off of the metal bucket frame, then this metal frame acts as a bucket organizer

FISH N' SEAT™ Pail w/ LN-1 Lunar Seat



Part No. **FNS-1** **ALL SEASON**

Ht's Fish N' Seat is a tall 6-gallon pail featuring a foam filled seat for "all-day" comfort. Silk-screened with the popular HT Logo the Fish N' Seat is ideal for summer or winter fishing.



Padded Bucket Seats™

Fits 5 or 6 Gallon Pails

Black
Super Thick
Soft Foam

Part No.
BKS-1D

Round Shaped
Over 3 1/2" Thick !



Padded Bucket Seats™

Fits 5 or 6 Gallon Pails

Black
Super Thick
Soft Foam

Part No.
BKS-1

Kidney Shaped
Over 2 1/2" Thick !



POLAR™ SWIVEL SEAT

Part No.
PSS-1 Fits 5 or 6 Gallon Pails

The Polar Swivel Seat rotates silently 360 degrees on our silent slider system. Fits all standard buckets and any flat surface !

ALL SEASON LUNAR SEAT™



Part No.
LN-1

- Comfortable foam seat
- Lightweight and compact
- Fits 5 or 6 gallon pails



SPORTS™ CHAIR

Part No.
SC-1

- Comfortable back and seat
- Lightweight and compact
- Set-up and breakdown in seconds



SPORTS™ CHAIR

Part No.
SC-3

3-Leg Design

- Comfortable back and seat
- Lightweight and compact
- Set-up and breakdown in seconds

Ice Combo Case

- Features extra heavy pvc tube and durable denier case with carry handle and convenient shoulder strap for hands free transport
- Padded tip to provide extra protection surrounds sensitive rod tips
- Soft padded liner sewn into reel pocket adds more protection
- Fits two combos up to 36" long



Part No.
DC-2

Deluxe Tackle Tote

*Handy Case for All of
Your Tackle !*



Part No.
RLD-2

- Case holds multiple items in three zippered storage compartments
- Shoulder and hand carry straps included
- Holds rods up to 31"

ROD LOCKER™

- Super tough material
- Works for two rod combos !
- Keeps lines from tangling
- Carry strap for easy transport
- Great for off-season storage
- Holds rods up to 29"

Part No.
RL-2



Iceman Bucket Tote

- Multi-pockets for tip-ups, jig poles, ice combos, & tackle !
- Easy-on velcro system
- Made of durable material
- Easy snap buckle for quick on-off release



Bucket Not Included

Part No.
IBT-5

SPORT TOWEL

Part No. **HST-50**



- Superior high stitch count towel material for long lasting durability
- Tri folded towel for use to dry hands many times while fishing
- Easy on and off metal clip for attaching to your belt loop, edge of a bucket, etc.

POLAR ROD GUARD

- Durable plastic sleeve slides over the rod tip and stops at the reel. The elastic band secures the tube to the combo.
- The top of the tube is open to allow for extremely long rods.
- Keep your rigged combo tangle free !
- Great inside rod bags and cases
- Perfect for protecting your rods and combos while transporting or storage

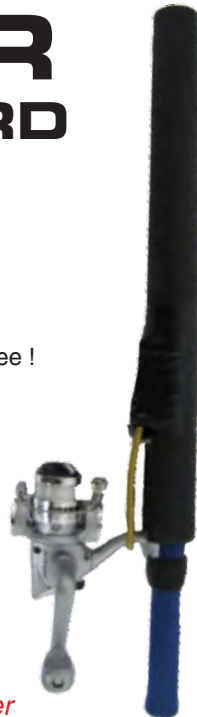

Combo Not Included

Part No.
PRG-1

for combos under 28" Long

Part No.
PRG-2

for combos 20" and Longer

POLAR GUARD

2-IN-1 ROD/ LURE SECURE WRAPS

- Prevents rod & lure damage
- Keeps rods from tangling
- Heavy duty denier material



Part No.
PGP-2

Ice Rod Rack

Part No.
IRR-12

- Holds 12 ice rod combos or rods
- Small size allows four racks per four foot modular
- Only 3 1/2" high - uses minimum retail space
- Durable and simple - use season after season
- Accommodates many sizes of handles
- Make more profit with less space !

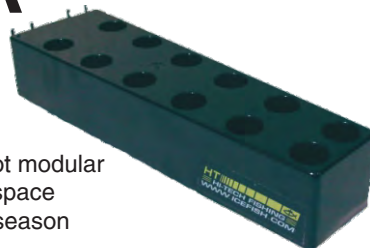

IRC-12 Clips for Rack - 2 per bag



Rigged & Ready to Fish !

Length
25"

Little Jigger Jig Poles

Part No.
JL-4

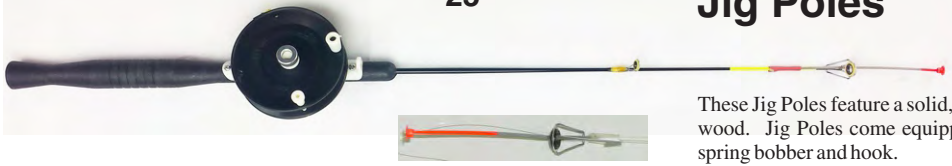

Bonus!
Spring Bobber Included

These Jig Poles feature a solid, high-impact, black handle that is stronger than wood. Jig Poles come equipped with fiberglass blank, 4 lb. test line, reel, spring bobber and hook.

Rigged & Ready to Fish !

Length
25"

Little Jigger Jig Sticks

Part No.
JL-10



Bonus!
Spring Bobber Included

These Jig Sticks feature a solid, high-impact, black handle that is stronger than wood. Jig Sticks come equipped with fiberglass blank, 4 lb. test line, linewinder, spring bobber and hook.

Rigged & Ready to Fish !

"SOFT-TOUCH" GRAPHITE JIG POLE

Part No.
EGL-24



Bonus!
Sponge Bobber and Hook Included

Fluorescent Tip

24" long

Fluorescent Tip

Ultralite Action !

Little Jigger Wooden Jig Pole

Part No.
PSG-28UL

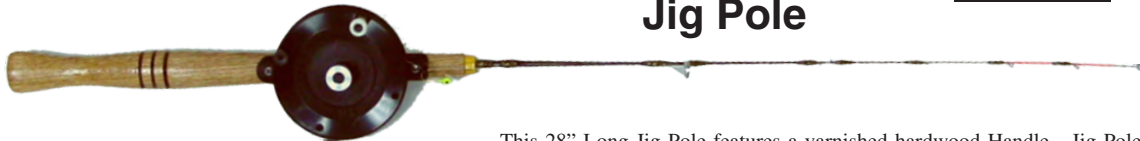

This 28" Long Jig Pole features a varnished hardwood Handle. Jig Pole comes equipped with a graphite composite rod blank w/ orange tip, 4 lb. test line, reel, bobber and hook.

Little Jigger Economy Jig Stick

Rigged & Ready to Fish !



Part No.
WJL-40 Length
25"

This Jig Stick features a wood handle. Jig Stick comes equipped with a fiberglass blank, linewinder, bobber and hook & 4# test line.

Little Jigger Wooden Jig Pole

Rigged & Ready to Fish !

Part No.
PSG-28



Neon Tip Medium Action

This 28" Long Jig Pole features a varnished hardwood Handle. Jig Pole comes equipped with a graphite composite rod blank w/ neon tip, 4 lb. test line, reel, bobber and hook.

ICE COMBO ASSORTMENT PACK

- 12 assorted combos w/ 1bb reel w/ line
- Medium action
- Neon colors - 4 each
Yellow
Green
Orange

Part No.
HTN-12A



Rod Rack Not Included



COMBO KITS

Hardwater Skinpack

Ready-To-Fish Kit

Kit includes Bonus:

- Snap-on spring bobber
- Teardrop styro-float
- Two ice jigs

Part No.
HWS-24SP

Spinning Combo Kit with OPT-101S Reel

Contains **Non-Lead Items**



Intrigue 3-in-1 Combo Kit

A great gift idea! Unique system includes a customized ice rod handle and series of 3 interchangeable rod blank actions: ultra light, light and medium, plus a 1 bearing Optimax spinning reel pre-spooled with line, and deluxe lure kit containing 4 assorted ice jigs, depth finder, 2 floats and bobber stops.

Part No.
INT-328K

Contains **Non-Lead Items**



“Ready to Fish” Combo Kits

24” fiberglass ice rod and Optimax spinning reel pre-spooled with line, a SBF-1s Snap-On spring bobber, 9 assorted pan fish jigs, 24 non-lead colored split-shot, 24 plastic wax worms, 24 plastic grubs, a ½ “E-Z ice out” sponge float and medium depth finder.

Part No.
HWS-24MK
Medium Action

Contains **Non-Lead Items**





“Ready to Fish” Jig Pole Kit

- | | |
|----------------------|-----------------|
| Kit includes: | Contains |
| 1 - 24" Graphite Rod | Non-Lead |
| 2 - Balsa Floats | Items |
| 1 - Sponge Bobber | |
| 1 - Depthfinder | |
| 5 - Asst Ice Jigs | Part No. |
| 1 - Jig Box | EGL-24K |



Lady Ice ROD N' REEL COMBOS

Part No.	<u>LIC-25LSC</u>	<u>LIC-25MSC</u>
Length	25" Long	25" Long
Handle	EVA foam	EVA foam
Action	Light	Medium



w/ LI-101
1/BB Reel
With Line !

Arctic Classic Ice Combos

- Custom tapered blank to give you the tip sensitivity to detect bites, but a strong backbone for a good hookset
- Easy ice out thin profile “D” style ice guides with an oxide inner ring
- Comfortable eva foam handle for a sure grip
- Ultra smooth 2 ball bearing reel with line with a 24 point stop system

Part No.	<u>AC-24LSC</u>	<u>AC-24MSC</u>
Length	24" Long	24" Long
Action	Light	Medium



w/ AC-102
2/BB Reel
With Line !

HARDWATER COMBOS

w/ 1 BB Reel
With Line!

Part No.	Length	Action
<u>HWS-24LSC</u>	24" Long	Light
<u>HWS-24MSC</u>	24" Long	Medium

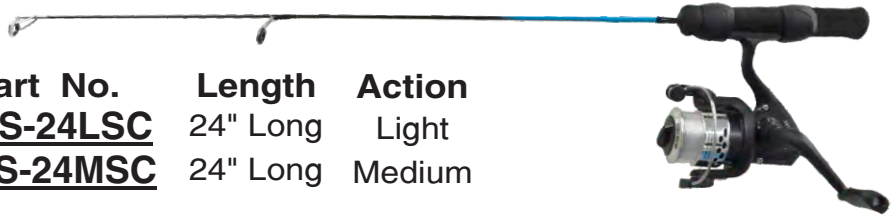

NEON

NEON ICE COMBOS

w/ 1 BB Reel
With Line!

Part No.	Length
<u>NIC-24LRC</u>	24" Light
<u>NIC-24MRC</u>	24" Medium

Hot Chartreuse



NEON ICE EXTREME COMBOS

w/ 1 BB Reel
With Line!

*HOT TWO-TONE
Orange/Chartreuse*
XCO-25MSC
25" Medium

*HOT TWO-TONE
Green/Chartreuse*
XGC-25LSC
25" Light



RED HOT

Red Hot Combos

w/ 1 BB Reel
With Line!

<u>RH-24ULSC</u>	24" Ultralight
<u>RH-24LSC</u>	24" Light
<u>RH-24MSC</u>	24" Medium



ICEMAN

ICEMAN Series



<u>ICL-24</u>	24" Light
<u>ICM-24</u>	24" Med
<u>ICM-28</u>	28" Med

With EVA foam handle and reel mounting rings
Composite rod blanks with hand-tied silver "D" style guides. Neon yellow tip for easy bite detection.

ICEMAN Combos



<u>ICL-24SC</u>	24" Light Action
<u>ICM-24SC</u>	24" Medium Action
<u>ICM-28SC</u>	28" Medium Action

w/ 1 BB Reel
With Line!

ICEMAN Specialty Combos

ICM-24MBR

24" Medium
w/ MBR-2 Reel



ICEMAN Specialty Combo Kits

Kit w/ Lures,
Depthfinder,
and Balsa Floats



Walley/Pike Combo Kit ICM-28WK

28" Long Medium
w/ OPT-101
1/BB Reel
With Line !

Panfish Combo Kit ICL-24PK

24" Long Light
w/ OPT-101
1/BB Reel
With Line !

Cherry Creek Combos

CR-24ULSC 24" Ultralight
CR-26MSC 26" Medium

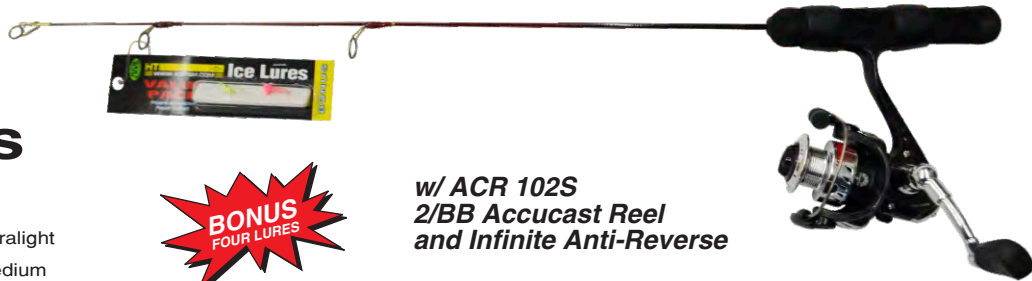

w/ ACR 102S
2/BB Accucast Reel
and Infinite Anti-Reverse

Prizm Pro ICE Combos

PPD-24MSC 24" Medium 2 Bearing reel with infinite anti-reverse
PPD-24LSC 24" Light 2 Bearing reel with infinite anti-reverse
PPD-27MLSC 27" Medium/Light 2 Bearing reel with infinite anti-reverse

- Come with the premium cork handled **Total Touch** handle system that gives you the "**Bite to Fight**" technology.
- Easy Ice out gunsmoke colored cermet thin profile guides
- Premium tapered fast tipped ultra sensitive blanks with hookset power
- Deluxe 2 bearing ultra smooth reel with infinite anti reverse

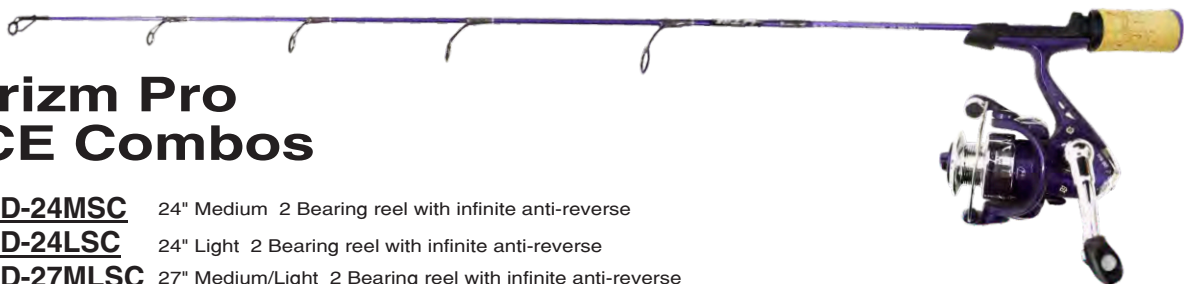

FISH HUNTER ICE COMBOS



Rod Camo Pattern

Part No.	Length	Action
FHI-24LSC	24" Long	Light
FHI-24MSC	24" Long	Medium
FHI-30MSC	30" Long	Medium

w/ CACR-102
2/BB Reel
and Infinite Anti-Reverse

WHIP IT STIX

WHIP IT STIX ICE Combos



WHS-24SULSC	24" Super Ultralight	3 Bearing reel with infinite anti-reverse
WHS-26LSC	26" Light	3 Bearing reel with infinite anti-reverse
WHS-30ULSC	30" Ultralight	3 Bearing reel with infinite anti-reverse

- Custom ultra fine tapered blank that is the lightest and most sensitive blank in the ice world today.
- Super fine special guides that give the fisherman the most sensitive bite detection possible
- Premium EVA Foam **Total Touch** handle system that gives the fisherman a direct touch to the blank to feel and detect every bite.
- Ultra smooth 3 bearing reel with infinite anti reverse

ICE BLUE

Ice Blue Series



Ice Blue Series Rods come with a corkalon handle and black rings. The blank is blue in color with dark blue guide wrappings, and "Fast Action" fluorescent orange tip.

Part No.	Length	Action
IB-18	18" Long	Superlight
IB-24	24" Long	Superlight
IB-30	30" Long	Superlight
IB-36	36" Long	Ultralight
IB-48	48" Long	Light

Ice Blue Combos

Part No.	Length	Action
IB-24SC	24" Long	Superlight
IB-30SC	30" Long	Superlight
IB-36SC	36" Long	Ultralight

w/ IB-102
2/BB Reel
and Infinite Anti-Reverse

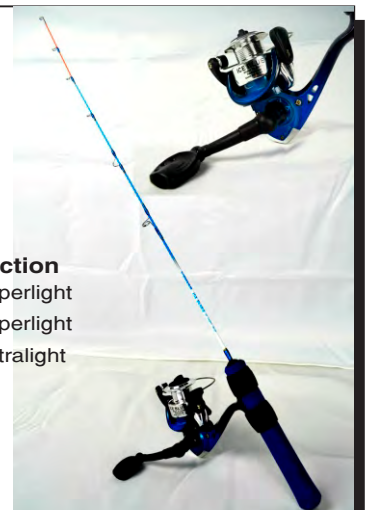

ICE BLUE JIG STIK

Part No. **IBM-30SC**
Medium/Plus Action
30" Spinning Handle

w/ **IB-102**
2/BB Reel
and **Infinite**
Anti-Reverse

Part No. **IBM-30**
Rod Only



30" Spinning Rod with hand-tied ceramic guides and corkalon foam handle for Comfort and Warmth. This rod is ideal for the big game ice angler who needs a stiff butt for hooksets, strength for fighting fish, yet a fast tip for sensitivity when jiggging through the ice.

Ice Blue Series

Part No. **IBM-24SC**
Medium Action
24" Long

w/ **IB-102**
2/BB Reel
and **Infinite**
Anti-Reverse

Part No. **IBM-24S**
Rod Only



24" Composite spinning rod with easy ice-out guides and sure-lock reel seat. This ice rod is ideal for the big game ice angler who enjoys fishing from the shack. *With Fluorescent Orange Tip.*

Ice Blue Series Medium/Plus Action



Part No. **IBM-24C** 24" Long

24" Composite casting rod with easy ice-out guides and sure-lock reel seat. This ice rod is ideal for the big game ice angler who enjoys fishing from the shack. *With Fluorescent Orange Tip.*

Ice Blues Trout Rods Heavy Action

Trout Rod with Trigger !



Part No. **IBT-28C**
Overall Length: 28"

Great Shanty Rod !

Part No. **IBT-44** Overall Length: 44" Heavy Action Ice Blue Trout Rods with extra large guides to help avoid ice-up. These rods are a "must" for the serious trout angler who enjoys ice fishing. Blank is blue in color with black guide wraps.

Part No. **IBT-34** Overall Length: 34"

Part No. **IBT-24** Overall Length: 24"

SLICK ICE

Slick Ice Ice Combos



Part No. **SI-28LDSC**
SI-28MDSC

Light Action
Medium Action

w/ **IS-502S**
2/BB Reel
with **Line!**



INTRIGUE XL

Intrigue XL Ice Combos

Bonus!
Spring Bobber



Part No.	Length	Action
INT-24LSC	24" Combo	Light
INT-24SC	24" Combo	Medium
INT-27MLSC	27" Combo	Med/Lite

w/ **DS-102S** 2/BB Reel with **Line!**
and **Infinite Anti-Reverse**

ICE MASTER DX ULTRALIGHT ICE ROD

- 29" premium tapered graphite composite blank
- Lightweight, precision placed guides
- Fixed reel seat
- Smooth 2 bearing reel with line

Part No.	Length	Handle	Action
IMX-29UL	29" Long	EVA	Ultralight
Combo IMX-29ULSC	29" Long	EVA	Ultralight



ICE BLUE PRO

ICE BLUE PRO ICE RODS



- Accented genuine cork handle
- Custom super sensitive blanks

Part No.	Length	Handle	Action
IBP-26UL	26" Long	Cork	Ultra Light
IBP-26M	26" Long	Cork	Medium
IBP-32UL	32" Long	Cork	Ultra Light

ICE BLUE PRO ICE COMBOS



Part No.	Length
IBP-26ULSC	26" Long
IBP-26MSC	26" Long
IBP-32ULSC	32" Long

**DNB-102 2/BB Reel
w/ Infinite Anti-Reverse
and Aluminum Spool**

ICEBERG COMBO SERIES



ICEBERG Combo Series

- Custom tapered pearl white blank
- E-Z ice out silver "D" guides
- Multi bearing reel with infinite anti-reverse
- Folding hook keeper
- Sleek custom light weight handle
- Multiple actions for all species of fish

Part No.	Length	Action
IBG-24ULSC	24" Long	Ultralight
IBG-25LSC	25" Long	Light
IBG-26MLSC	26" Long	Medium Light
IBG-27MSC	27" Long	Medium

SLAB STOPPER



HT 
WWW.HTENT.COM™

Slab Stopper Combos

Part No.	Length	Action
<u>SLTS-24ULSC</u>	24" Combo	UltraLite
<u>SLTS-25MSC</u>	25" Combo	Medium
<u>SLTS-26LSC</u>	26" Combo	Light
<u>SLTS-27MLSC</u>	27" Combo	Med/Light



BONUS!
Spring
Bobber

- 2 bearing IAR reel **with line!**
- Graphite blank
- Cork handle



POLAR GOLD

Polar Gold Ice Rod Series

Part No.	Length	Handle	Action
<u>PLG-25UL</u>	25" Long	Spinning	Ultra-Light
<u>PLG-25L</u>	25" Long	Spinning	Light
<u>PLG-25M</u>	25" Long	Spinning	Medium
<u>PLG-28MH</u>	28" Long	Spinning	Med/Heavy



Polar Gold Ice Combos

Part No.	Length	Action
<u>PLG-25LEC</u>	25" Combo	Light
<u>PLG-25ULEC</u>	25" Combo	Ultra-Light
<u>PLG-25MEC</u>	25" Combo	Medium
<u>PLG-28MHEC</u>	28" Combo	Med/Heavy

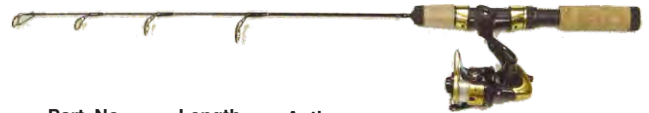

- Easy ice out guides
- 2 bearing IAR reel **with line!**
- Cork handle

SNOW CAMO

SNOW CAMO ICE COMBOS

Part No.	Length	Action
<u>FHSC-25LSC</u>	25" Long	Light
<u>FHSC-26MSC</u>	26" Long	Medium
<u>FHSC-27MLSC</u>	27" Long	Medium Light



w/ Multi-Bearing
Snow Camo
Accucast Reel

- Custom tapered snow camo pattern blank
- "No Ice-Up" gold dyna-flow guides
- Genuine cork handle



ICE LOGIC

HT **ICE** SLX Logic series

Specially Designed Micro Reel

- Superior custom tapered carbon blanks for superior sensitivity
- Special thin profile aluminum oxide guides for no icing up
- Special sure grip handle to give the ultimate bite detection
- Custom actions in series to accommodate all species of fish
- Deluxe 4 bearing reel with infinite anti-reverse
- Reel has a machined aluminum spool and aluminum arm
- Reel has a soft rubber handle for a sure grip while retrieving your line

Part No.	Length	Action	Bearings	Reel
<u>ILC-24ULSC</u>	24" Long	Ultralight	4	ILC-104A
<u>ILC-25LSC</u>	25" Long	Light	4	ILC-104A
<u>ILC-26MSC</u>	26" Long	Medium	4	ILC-104A
<u>ILC-28MLSC</u>	28" Long	Medium/Light	4	ILC-104A



HT Premium Polar Lite Noodle Ice Rod Series

Spinning Rods featuring HT's exclusive SENSATOUCH "Noodle" action. Custom Designed genuine cork handle and blank with reel seat make this series among the most sensitive ever designed.

Genuine Cork Handle

Part No.	Length	Action
<u>PLC-21N</u>	21"	Noodle
<u>PLC-24MI</u>	24"	Micro
<u>PLC-27LM</u>	27"	Light/Med

Premium Polar Lite Noodle Ice Rod Combos

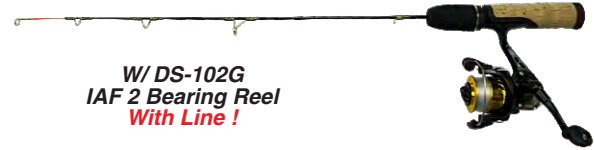

W/ DS-102G
IAF 2 Bearing Reel
With Line !

Genuine
Cork Handle

Part No.	Length	Action
<u>PLC-24NC</u>	24"	Noodle

Specialty Polar Lite Ice Rod

Polar Lite Specialty rods with easy ice-out guides, reel seat, and an action designed specifically for walleye/perch or trout/pike.

Genuine Cork Handle

Part No.	Action	Length
<u>PLC-27M</u>	Walleye/Perch	27" Medium
<u>PLC-34H</u>	Trout/Pike	34" Heavy
<u>PLC-25M</u>	Walleye/Pike	25" Medium
<u>PLC-25UL</u>	Panfish/Perch	25" Ultralight

Polar Lite Jiggin' Stik Combos



W/ DS-102G
IAR 2 Bearing Reel
With Line !

Genuine
Cork Handle

Part No	Length	Action
<u>PLC-24MISC</u>	24"	Micro
<u>PLC-25ULSC</u>	25"	Ultra-light
<u>PLC-25MSC</u>	25"	Medium

STILLFISH

Stillfish Polar Lite Series



New Removeable Spool !

Super Sensitive Spring Bobber Included

Metal Tip

Graphite Stillfish rod with cork handle, super-sensitive spring bobber, line and ice jig. This rod has HT's exclusive sensa-touch action and a metal tip for added sensitivity.

Part No

<u>PL-24C</u>	24"
<u>PL-31C</u>	31"

Genuine
Cork Handle

Medium
Action

ICE TEK

HT ICE TEK PRO COMBO SERIES

Specially Designed Micro Reel

- Select tapered graphite blank with super sensitive fast action tip
- Genuine cork handle; special oversized "d" style guides to help reduce ice-up
- Super smooth four bearing infinite anti-reverse spinning reel w/ two color machined aluminum spool & handle



Part No.	Length	Action	Bearings	Reel
<u>ITK-24LSC</u>	24" Long	Light	4	ITK-104A
<u>ITK-26ULSC</u>	26" Long	Ultralight	4	ITK-104A
<u>ITK-26MSC</u>	26" Long	Medium	4	ITK-104A
<u>ITK-27MLSC</u>	27" Long	Medium/Light	4	ITK-104A

TIGHT LINE



HT 
WWW.HTENT.COM™

TIGHT-LINE COMBOS



- Custom tapered carbon blank
- Easy flow "no ice-up" guides
- Genuine cork rear grip handle with EVA foam fore-grip for maximum comfort

Part No.	Length	Handle	Action
<u>TLS-24ULSC</u>	24" Long	Genuine Cork	Ultralight
<u>TLS-27MLSC</u>	27" Long	Genuine Cork	Medium Light

REDUCES LINE COIL & TWISTS!
Specially designed reel with large arbor spool & direct line release reduces line coil twists!

LAKER PRO

LAKER PRO COMBOS / ICE RODS

Part No.	Length	Handle	Action
<u>LKP-32MHSC</u>	32" Long	EVA	Med/Heavy
<u>LKP-38MHSC</u>	32" Long	EVA	Med/Heavy
<u>LKP-32MH</u>	32" Long	EVA	Med/Heavy
<u>LKP-38MH</u>	38" Long	EVA	Med/Heavy
<u>LKP-44MH</u>	44" Long	EVA	Med/Heavy
<u>LKP-45H</u>	45" Long	EVA	Heavy

NEW! LKP COMBOS

- Admirable strength & backbone provide ample hook setting & fish fighting power
- Perfect tip action ensures consistent line tension when working & fighting fish

6 Bearing Reel w/ Aluminum Spool

ARCTIC BAY

Arctic Bay SLX Combos

SOLID CARBON BLANK!



Genuine Cork Handle

These combos are one of our highest quality solid carbon ice rod combos. Select, custom designed solid carbon blanks are tapered for highest sensitivity. The fully genuine cork handles feature a top-lock down fixed reel seat. The correct number of single foot low profile guides are scientifically placed for precise action.

w/ ACR-106A 6 Bearing Reel Infinite Anti-Reverse

Part No	Length	Action
<u>ABS-26LSC</u>	26"	Light
<u>ABS-25MSC</u>	25"	Medium

SAPPHIRE ICE

Sapphire Ice Series



- Select tapered im-8 solid carbon blanks
- Full genuine cork handles with rings (32" and under)
- Full genuine cork handles with fixed reel seats (36" and over)
- Premium aluminum oxide guides
- Matte gray finish with burgundy/gold accents
- Hook keeper

GENUINE CORK HANDLE W/ RINGS

Part No	Length	Action
<u>SPI-24L</u>	24"	Light
<u>SPI-26M</u>	26"	Medium
<u>SPI-32ML</u>	32"	Med/Light
<u>SPI-32M</u>	32"	Medium

Sapphire Ice Series

GENUINE CORK HANDLE W/ FIXED REEL SEAT



- Select tapered im-8 solid carbon blanks
- Premium aluminum oxide guides
- Matte gray finish with burgundy/gold accents
- Hook keeper

Part No	Length	Action
<u>SPI-36DS</u>	36"	Dead Stick
<u>SPI-36M</u>	36"	Medium
<u>SPI-42MH</u>	42"	Med/Heavy
<u>SPI-45H</u>	45"	Heavy

DEEP BLUE DROPSPIN Series

HT's Deep Blue rod features a select tapered blank with oversized "D" Guides and a crushed cork fixed reel seat handle, while the matching four bearing reel features a machined aluminum spool with magnetic brake, infinite anti-reverse, levered free spool allowing for quick drops directly to fish, and an oversized double handle.

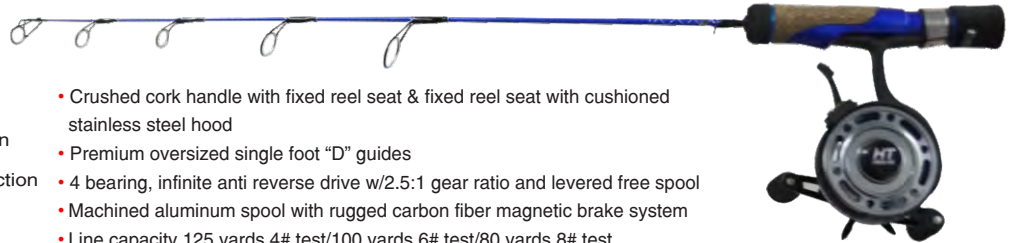

W/DBDS-100

Part No:

DBDS-25LSC 25" Light Action

DBDS-27MSC 27" Medium Action

- Crushed cork handle with fixed reel seat & fixed reel seat with cushioned stainless steel hood
- Premium oversized single foot "D" guides
- 4 bearing, infinite anti reverse drive w/2.5:1 gear ratio and levered free spool
- Machined aluminum spool with rugged carbon fiber magnetic brake system
- Line capacity 125 yards 4# test/100 yards 6# test/80 yards 8# test
- Oversized double handle for easy grip even while wearing gloves

ICE ADDIX

ICE ADDIX Pro XT



- Premium blank tapers with a fast tip and a sure hook set
- Customer thin profile d style guides for sensitivity and for easy ice out
- **Total Touch** handle with "Bite to Fight" technology to never miss a fish
- Folding hook keeper included
- Ultra smooth 4 bearing aluminum spooled reel with an extended neck to enable while wearing of gloves
- Reel has infinite anti reverse feature with a soft paddle for a sure grip

Part No.	Length	Action	Bearings	Reel
IAD-25MLSC	25" Long	Medium/Light	4	Aluminum
IAD-24ULSC	24" Long	Ultraight	4	Aluminum
IAD-26LSC	26" Long	Light	4	Aluminum
IAD-27MSC	27" Long	Medium	4	Aluminum

ARCTIC FUSION

Arctic Fusion TX series

Specially Designed

"Total Touch"

New Total Touch Handle System

- Sleek custom handle for a sure grip to feel the slightest bite
- Custom tapered blanks with a fast tip action to detect all bites
- E-Z out ice guides for no ice up
- Species specific actions in this series
- Custom 3 bearing reel with infinite anti-reverse
- Handle has a sure grip paddle for easy use



Part No.	Length	Action	Bearings	Reel
AFN-22LSC	22" Long	Light	3	AFN-103A
AFN-25MSC	25" Long	Medium	3	AFN-103A
AFN-26MLSC	26" Long	Medium Light	3	AFN-103A

FASTSTIX PRO SX

HT has once again taken ice rod advancement to an all new level! The revolutionary Fast Stix angular blank incorporates an oblique sheer beginning with a traditional round base that graduates into a horizontally flattened, rectangular design that is diametrically stronger and adds significantly greater backbone and power before tapering into a well-balanced, thinner "spring tip" section, ultimately providing a unique action featuring a supremely heightened level of sensitivity!

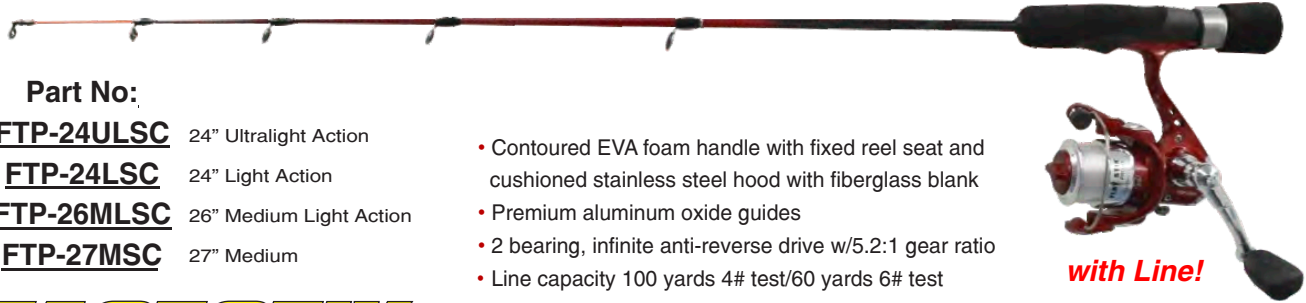

Part No:

- FTP-24ULSC** 24" Ultralight Action
- FTP-24LSC** 24" Light Action
- FTP-26MLSC** 26" Medium Light Action
- FTP-27MSC** 27" Medium

- Contoured EVA foam handle with fixed reel seat and cushioned stainless steel hood with fiberglass blank
- Premium aluminum oxide guides
- 2 bearing, infinite anti-reverse drive w/5.2:1 gear ratio
- Line capacity 100 yards 4# test/60 yards 6# test

with Line!

FASTSTIX EXTREME DX

Heightened Sensitivity!!

Extra Fast Tip!!



Part No:

- FTX-24ULSC** 24" Ultralight Action
- FTX-24LSC** 24" Light Action
- FTX-27MLSC** 27" Medium Light Action
- FTX-28MSC** 28" Medium

- HT "TOTAL TOUCH" cork handle with exposed E-glass blank
- Lightweight, ringed single foot easy ice out guides
- 4 bearing, infinite anti-reverse drive w/5.2:1 gear ratio
- Vented, machined aluminum spool
- Line capacity 145 yards 4# test/90 yards 6# test

BIG EYE COMBOS

- Special fast tip action with backbone for ultimate sensitivity and hook set
- Super sized "no ice-up" guides
- Premium black EVA foam split handle for ultimate bite detection

Special Translucent Ice Blank Pattern

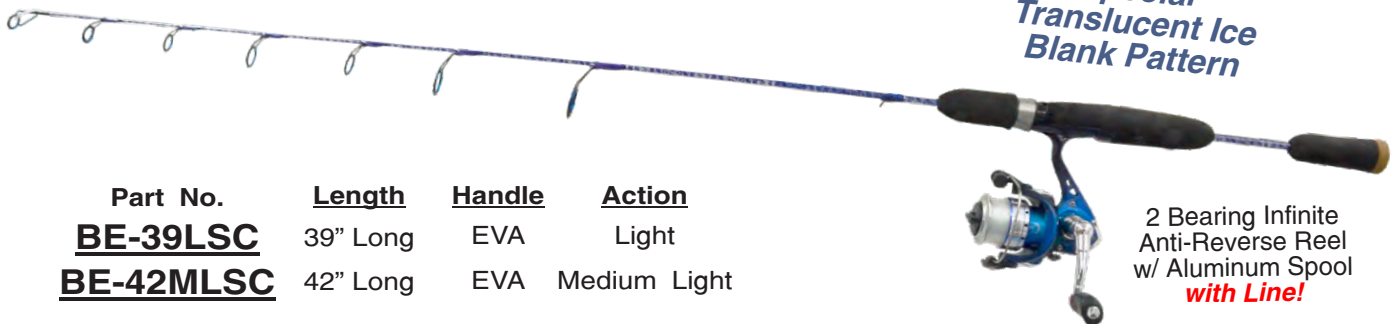

Part No.	Length	Handle	Action
BE-39LSC	39" Long	EVA	Light
BE-42MLSC	42" Long	EVA	Medium Light

2 Bearing Infinite Anti-Reverse Reel w/ Aluminum Spool
with Line!

HT

HI-TECH FISHING

FISH-N-BUCKET

31 Piece ROD COMBO KIT

1 per case

ROD COMBO KIT CONTAINS

- 6 Gallon Pail with Padded Seat
- One Pail Wire Rod Holder
- Six Compartment Tackle Box
- 3 in 1 Rod Systems
3 Actions:
(Light, Medium, Heavy)
- 2 Bearing Ultralight Reel with Line and Infinite Anti-Reverse
- Poly Flex Skimmer
- Minnow Scoop - Hot Yellow
- 8 piece Deluxe Walleye Kit
- 14 piece Panfish Jig Kit with Floats and Depthfinder



**Pre-Book
Only by
March 1st!**

Part No.
FRK-31



ACCUCAST *Direct To Guide Technology* ULTRALIGHT SPINNING REELS *Infinite Anti-Reverse*



Part No.
ACR-106AC



*Mirrored
Gunsmoke Color !*

Line
Capacity
(Lbs/Yds)
4/100 6/60

Gear Ratio: 5.2:1

Vented Aluminum Spool *Infinite Anti-Reverse*



Part No.
ACR-105WAC



*Aluminum
Wide Arbor Spool*

Gear Ratio: 5.1:1



Part No.
ACR-102C



*Silver
Color !*

Line
Capacity
(Lbs/Yds)
4/100 6/60

*Silver Plated Spool
Line Included !*

Gear Ratio: 5.2:1

MASTERPIECE ULTRALIGHT SPINNING REELS

All Masterpiece reels feature: • Infinite anti-reverse
• Machined aluminum handle with wooden knob!
• Machined aluminum spool

Line Capacity (Lbs/Yds):
4/100 6/60



Part No.
MP-1750AC



*Gunsmoke
Aluminum*

Gear Ratio: 4.2:1

TIGHTLINE *ALL SEASON ICE FLY REEL*



- Lightweight premium carbon fiber body
- Keep your line coil free when using this reel
- Positive drag system
- Great for a pencil style grip when using with your favorite ice rod
- Catch the big ones with this super deluxe reel
- Reversible left / right
- Direct drive

Part No.
TLS-34



PRO DX TIGHTLINE

Part No. *ICE FLY REEL*
TL-100D



- Machined aluminum body drag control knob and handle - lightweight carbon fiber spool
- Push button free spool setting moves even the smallest lures and baits to bottom quickly
- Deluxe double handle with oversize paddles for easy handling
- Positive drag system - **2.6:1 Gear Ratio**
- Reversible bearing allows on-off "click" right or left side retrieve

DEEP BLUE DROPSPIN TIGHTLINE REEL



**3+1
Stainless
Steel
Bearings**

- Free spool feature allows user to get lures down to fish quickly
- Multi-setting star drag - machined aluminum spool - carbon fiber magnetic brake system
- 4 bearing drive with 2.5:1 gear ratio
- Line capacity 125 yards/4# test - 100 yards/6# test - 80 yards/8# test
- Oversized double handle for easy grip even while wearing gloves

Part No.
DBDS-100



Denali Reel All-Season SPINNING REEL

With Line!

Part No.
DNB-102AC
Gear Ratio 5.2:1

Therma-Lube Lubricant Keeps Reel
Operating in the Coldest Temperatures.



Denali Reel All-Season SPINNING REEL

With Line!

Part No.
DS-102GC
Gear Ratio 5.2:1

Therma-Lube Lubricant Keeps Reel
Operating in the Coldest Temperatures.



Denali Reel All-Season SPINNING REEL

With Line!

Part No.
DS-102SC
Gear Ratio 5.2:1

Therma-Lube Lubricant Keeps Reel
Operating in the Coldest Temperatures.



Optimax All-Season SPINNING REEL

With Line!

Black Body w/ Silver Spool
Part No.
OPT-101SC
OPT-101S (BULK) #605011
Gear Ratio 5.1:1

This reel is lightweight and graphite reinforced.
It is equipped with bail roller & front drag.



World's Smallest Level Wind Reel

LEVEL WIND BAIT CAST REEL

Part No.
HT-5500

Features

- Star drag system
- (3) three bearings
- Infinite anti-reverse
- Machined aluminum spool
- Wood barrel style paddle
- Gear Ratio: 4.2 to 1
- Level wind retrieve system

Micro TUNDRA Spinning Reels

Part No.
TN-500SC
Silver
Gear Ratio: 5.2:1

- Special zinc drive gear
- Machined pinion gear
- Automatic internal bail trip
- Smooth, coil spring loaded drag



Part No.
TN-500GC
Gold
Gear Ratio: 5.2:1

- Special zinc drive gear
- Machined pinion gear
- Automatic internal bail trip
- Smooth, coil spring loaded drag



INTRIGUE DX ULTRALIGHT SPINNING REELS

Part No.
IS-502SC
Gear Ratio 4.2:1

The Intrigue reel is an ultra-smooth, ultralight deluxe spinning reel that is great for your ultralite rods in the summer and your ultralite poles in the winter.



Optimax All-Season SPINNING REEL

Black Body w/ Gold Spool
Part No.
OPT-101C
OPT-101 (BULK) #605010
Gear Ratio 5.1:1

This reel is lightweight and graphite reinforced.
It is equipped with bail roller & front drag.

HT DELUXE MINI BAIT CAST REEL



Part No.
MBR-2
All Black Color
Individually Boxed



ICE REEL

Part No. **R-10B**

Black Reel



Part No. **BR-10B**

Attaches to any Jig Pole handle. Comes with plastic bracket and 2 screws for easy mounting. Features a positive "drag" for easy setting of line tension and Reel Linemarker.

BULK
Priced By Dozen

ULTRALITE ICE REEL

Part No. **UIR-1** Black



Easily attached to any ice rod with rings. Also attaches to any jig pole handle with plastic bracket and 2 screws. Features a positive "drag" for easy setting of line tension.

RATTLE REEL

Part No. **RR-10**

Attaches to any Jig Pole handle. Comes with bracket and 2 screws for easy mounting to wall or handle. Features a positive "drag" for easy setting of line tension. Reel "rattles" when turned to signal when fish strikes.



COATED 1 1/4 OZ. DEPTHFINDERS

1 Hot Pink & 1 Hot Yellow!



Part No. **FDFB-3D**

2 Colors per Bubble Card

Vinyl Coated

Part No. **FDF-100D**

100 Depthfinders per Bulk Pack
50 of each Color

Part No. **FDFB-3**

2 Colors per Bubble Card

Painted

Part No. **FDF-100**

100 Depthfinders per Bulk Pack
50 of each Color

ALLIGATOR DEPTHFINDERS

Part No. **DFA-1**

1/2 oz.

Part No. **DFA-2**

1 1/4 oz.

1 per Bubble Card



Part No. **DFA-50**

1/2 oz.

Part No. **DFA-250**

1/4 oz.

50 per Package

SPRING CLIP DEPTHFINDERS



Part No. **DFSB-8**

ORANGE

1 per Card

1 1/4 oz.

Part No. **DFS-850**

BULK 50 per pkg

Two-Tone Glow Color

1 1/4 oz.

PAINTED DEPTHFINDERS

Part No. **DFB-4T**

1 per Bubble Card

Bulk

Part No. **DF-450T**

50 per Package



NON-CHIP DELUXE VINYL COATED DEPTHFINDERS



Blaze Orange

Part No. **DFB-2D**

2 per Bubble Card
3/4 oz.

Part No. **DFB-4D**

2 per Bubble Card
1 1/4 oz.

Bulk Part No. **DF-250D** 50 per Package

Bulk Part No. **DF-450D** 50 per Package



BULK #45 ELECTRICAL CLIPS

Part No. **EC-1000**

1,000 per Package

PAINTED DEPTHFINDERS

Part No. **DFB-2** 3/4 oz.

2 per Bubble Card

Bulk

50 per Package

Part No. **DF-250**

50 per Package

Part No. **DFB-4** 1 1/4 oz.

2 per Bubble Card

Bulk Part No. **DF-450** 50 per Package

Blaze Orange



Adjustable Drag



Clamp-On Rattle Reel

with Arm & Clamp

Part No. **RRC-1**

The Clamp-On Rattle Reel is jumbo size which makes it ultra-smooth. The bells are the fish bite alarm. Comes complete with hardware for mounting.
1500 foot capacity

DELUXE Slab Stopper Pole Reel



Part No. **ALL SEASON SSPR-10**

- 2" diameter 1" arbor diameter
- Built-in line guide
- Adjustable spool tension settings
- Ultra smooth

Adjustable Drag



Wall Mounting Rattle Reel

Part No. **RRH-1** with Arm & Hinge

The Wall Mounting Rattle Reel is jumbo size which makes it ultra-smooth. The bells are the fish bite alarm. Comes complete with hardware for mounting.
1500 foot capacity

DELUXE Slab Master Reel



Part No. **ALL SEASON SMR-60**

- 2 Bearing Drive System
- 2.5" diameter 2.25" arbor diameter
- Built-in line guide
- Adjustable spool tension settings
- Ultra smooth

Deluxe Rattle Reel



Part No. **RR-1A**

Pail Type

1500 foot capacity

with Aluminum Arm

Adjustable Drag

Deluxe Rattle Reel

1500 foot capacity

Adjustable Drag



with Aluminum Arm

Part No. **RR-1H**

Hinge Type



Stillfish Reels

Handle O.D. Size **3/4" Only!**

Part No. **S-12 Bulk by Dozen**

Please Order S-12 in Dozen Quantities

A unique, custom-designed reel for mounting on the end of your Rod Handle. The unique design allows the fishing line to "pass through" any "hollow" rod blank.

POLAR NIGHT STAR

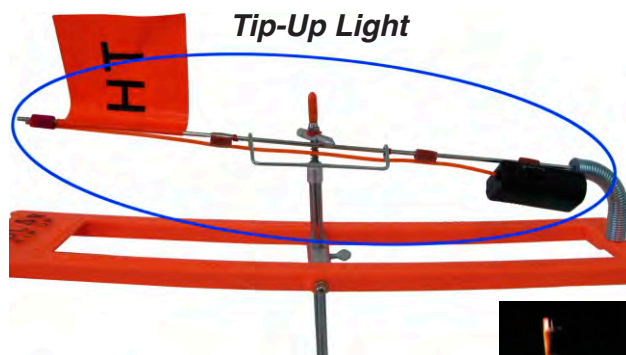

Tip-Up Light

Part No. **PNRS-1**

- Ultra bright fiber optic light
- Light remains on at all times whether in the horizontal or vertical position or in the flashing or continuous mode
- As the light is on continuously this allows you to see your tip up at all times and for oncoming vehicles, ATV's and snowmobilers
- Uses one "AA" battery that is not included

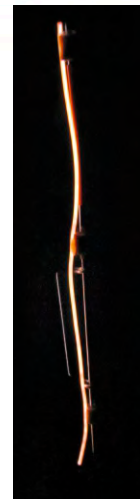





THE OMNI "STRIKE" LITE

w/ New Clip System



Lite is OFF  Lite is ON 

UNIQUE FEATURES

- Super-Lightweight (1/4 oz.)
- Works on all flag wire and flag steel style tip ups
- Easy-to-Mount "CLIP-ON" feature
- High-Intensity red light can be seen 50 to 100 ft. away
- Comes with 1 BR-435 pin style battery

ENVIRONMENTALLY SAFE TILT SWITCH PROTECTING NATURE

Part No. **ML-2**

Micro Shot Dial Box Assortment



Part No. **NX-200**

HT micro shot dial box has No.2 through No. 8 shot. Designed for ice fishing with light jigs.

HT Lithium Battery Replacement

w/ Bonus LED Clip-on Light



Part No. **MLB-1**

- Superior long lasting BR-435 universal lithium battery
- Bonus LED clip on light included to be used as a low intensity utility light
- Led light comes with clip so you can clip it to your jacket, shirt or hat
- Battery works with HT's ML-2 OMNI strike lights and most summer lighted floats.

HT NORTHSTAR TIP-UP FLAG ASSEMBLY BITE INDICATOR LIGHT



Part No. **NTB-1**

- Super bright red L.E.D. illuminates when flag lifts from horizontal to vertical position
- 16.5" tall for increased visibility
- Fits most major tip-up brands
- Uses three LR44 button cell batteries (included)

All Season Micro-Lite

Part No. **ML-7**

Sound & Light Indicates Strike !



This 4-season Micro-Lite is designed for use on any Tip-Up. Comes equipped with a micro sensitive, switch for easy line release. Comes with lite and two standard 1.5V batteries (hearing aid, 312 or 392, or equivalent)

Night Star Strike Light

w/ Dual Yellow/Red Light System



NEW and IMPROVED TILT SWITCH!



Part No. **NSL-1**

The NightStar Strike Lite easily attaches to the flag apparatus of most tip-ups on the market. The "dual strike light" makes this strike light like no other light. Simply choose hi-viz "red" or ultra-bright "yellow" as your indicator. Your fishing friend may choose the other color. Now you can fish side by side and instantly know who has the bite! Comes with 2 DR44 button cell alkaline batteries.

HT ILLUMINATOR LIGHTED TIP-UP FLAG ASSEMBLY



Part No. **ILTB-1**

- Super bright fiber optic line illuminates entire length of flag assembly
- Stands 16.5" high for heightened visibility
- Two settings: continuous on & flashing mode
- Fits most major tip-up brands
- Uses three LR44 button cell batteries (included)

Tip-Up and Ice MonoFilament Lines



POLAR ICE **BRAIDED** **ICE LINE**

HT's POLAR ICE Braided Ice Line is the favorite line of ice fishing enthusiasts across North America. This strong braided black nylon line has low memory and low stretch qualities at economy prices. This POLAR ICE Braided Ice Line is available in three popular sizes.

50 yds. Per Spool - Black Color Only

Part No.	Lb. Test	Part No.	Lb. Test
IL-5015	15#	IL-5030	30#
IL-5020	20#	IL-5040	40#
IL-5025	25#	IL-5050	50#

100 yds. Per Spool - Four Popular Colors

Black Color		Sand Color	
Part No.	Lb. Test	Part No.	Lb. Test
IL-1020	20#	ILS-1020	20#
IL-1030	30#	ILS-1030	30#
IL-1040	40#	ILS-1040	40#
IL-1050	50#	ILS-1050	50#
Red Color		Green Color	
Part No.	Lb. Test	Part No.	Lb. Test
ILR-1020	20#	ILG-1020	20#
ILR-1030	30#	ILG-1030	30#
ILR-1040	40#	ILG-1040	40#
ILR-1050	50#	ILG-1050	50#

PREMIUM **POLAR ICE** **VINYL TIP-UP LINE**

Specially Designed Line for Ice Fishing !

Part No.	Part No.
TL-15 25 yds. / 15# Test	TL-25 25 yds. / 25# Test



Each Lid Opens Up Separately

Micro Six Compartment Jig Boxes

Part No. TBM-6

Micro Six Compartment Jig Boxes

Part No. TBLM-6



ICE RED

SPECIAL ICE FISHING LINE

110 yds. / Red Great for Leader Material

1 spool per blister



- Specially treated for low temps !
- Special materials & technology
- Extremely soft
- Extremely low memory
- Wear / abrasion resistant
- Red color for good visibility

Part No.	Lb Test
BRL-2	2#
BRL-4	4#
BRL-6	6#
BRL-8	8#

Micro Pro Jig Box

Five Compartments

With Magnets

Single Sided

Part No. MPS-5M

Air Tight Seal



TELESCOPIC POLAR SKIMMER

5" CUP SIZE

Extends to 36" Long !

Part No. TPS-36



The Telescopic Polar Skimmer is a good all-around sturdy skimmer. The telescopic feature allows you to skim holes without the need to bend over as far. It collapses for easy storage and transport.

ICEMAN SKIMMER

Part No. ICS-1

18" Long w/ 5" Cup



- Hook on end of handle
- Rimmed cup for E-Z ice removal
- Extra strong wire handle
- Special yellow zinc plating

POLAR THREE-IN-ONE SKIMMER

Part No. HTS-1

23" Long w/ 6" Cup

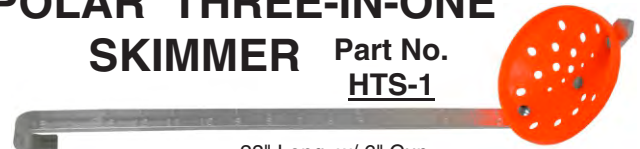

HT's 3-in-1 Skimmers feature a metal handle with a handy ruler stamped into it. The long lasting riveted construction and durable plastic cup make it perfect for fishing in cold weather. Ice can be squeezed off the plastic flex-cup without breaking or losing shape even in the coldest weather. The cup end of the skimmer also features an ice chipper that is ideal for chipping away skim ice.

ICEMAN CHIPPER SKIMMER

Part No. ICS-3

w/ Ruler & Chipper



- Extra long 22" handle
- 16" ruler on handle
- Handy ice chipper on end
- Extra large holes in cup
- E-Z "ice-off" coated 5" cup

POLAR CHIP N' DIP SKIMMER

Part No. CD-18 23" Long w/ 6" Cup



HT's Chip N' Dip Skimmer features a heavy duty metal handle with a handy ruler stamped into it. The long lasting riveted construction and durable metal cup make it perfect for fishing in cold weather. The heavy duty welded chipper is ideal for opening old holes or removing skim ice.

POLAR ALUMI-FLEX SKIMMER

Part No. PFS-1D

16" Long w/ 5" Cup



HT's Poly-Flex Skimmers feature an aluminum handle and plastic cup making it perfect for fishing in cold weather. Ice can be squeezed off the plastic flex-cup without breaking or losing shape even in the coldest weather.

RIMMED CUP METAL SKIMMER

Part No. ESK-2D

18" Long w/ 6" Rimmed Cup



Riveted Handle

POLAR FLEX SKIMMER

Part No. PFS-1

16" Long w/ 5" Cup w/ EVA Handle



HT's Poly-Flex Skimmers feature a plastic handle and plastic cup making it perfect for fishing in cold weather. Ice can be squeezed off the plastic flex-cup without breaking or losing shape even in the coldest weather.

POLAR METAL SKIMMER

Part No. ESK-1 18" Handle w/ 4" Cup

Part No. ESK-2 18" Handle w/ 6" Ladle



HT offers a New Economy Metal Skimmer featuring a 4" or 6" ladle for easy skimming. Excellent value!



Chip n'Dip Premium Folding Skimmer

Part No.
CDF-18

- Has a "Sure Lock" folding system that is sturdy and strong
- Fold up feature allows for easy transport and storage
- Premium chipping blade with cover on one end
- Never hits the bucket handle once in the locked folded position

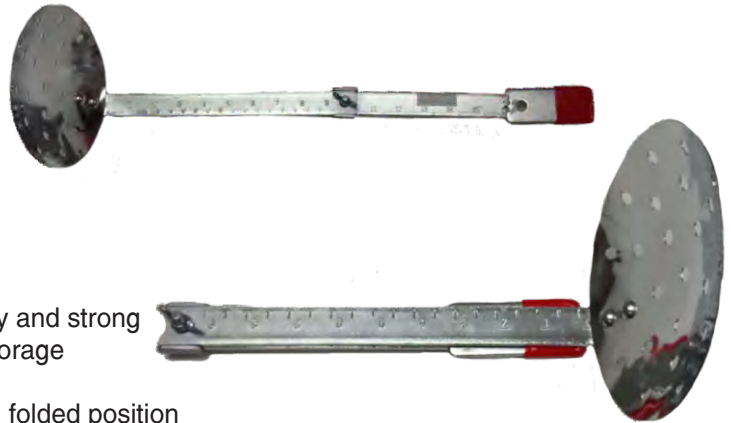

ICE SKIMMER with Folding Handle System

Part No.
ESK-2F

- Premium strong metal folding handle with a sure lock system
- Folding system allows for easy transport and storage
- Special 2 piece locking system that is strong and sturdy
- Six inch scoop diameter to quickly clean out the slush



Part No.
FMS-1 6" Spreader
FMS-2 10" Spreader

Extra durable spring steel construction.
Now in 2 different sizes.

Fish Mouth Spreader

POLAR GAFF With Ruler

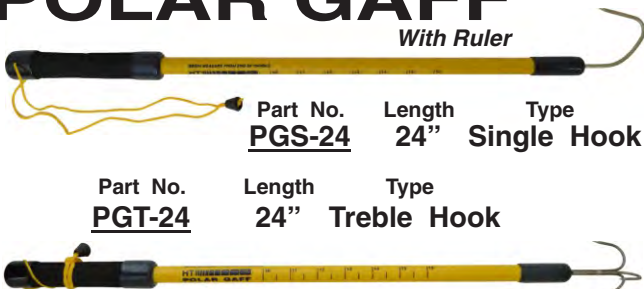

Part No. **PGS-24** Length 24" Type Single Hook

Part No. **PGT-24** Length 24" Type Treble Hook

GAFF HOOKS

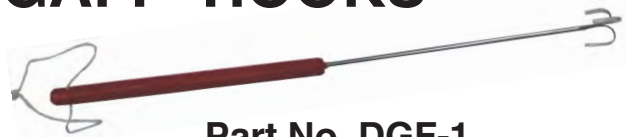

Part No. **DGF-1**
25" Long

This Gaff Hook is made of durable Steel with a large Treble Hook welded into the Tip for sure "gaffing" ability. The Handle has a "sure-grip" texture that prevents "slipping" when your hands are cold or wet.

HT EYEBUSTER WITH LINE CUTTER

- Keep your jig eyes clean always with this tool
- Premium alloy spring steel for the best function
- Red powder coated grip for easy use with slippery or wet hands
- Never use another jig or lure again to open up the eye of your favorite jig or lure
- Never dull another jig or lure again when you have this great tool in your tackle box



Part No.
EB-16

TELESCOPIC POLAR GAFF

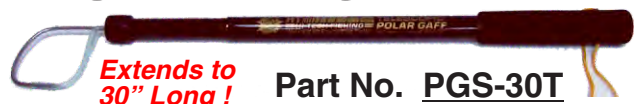

Extends to 30" Long!
Part No. **PGS-30T**

The Telescopic Polar Gaff is a good all-around gaff hook. The telescopic feature allows you to gaff fish without the need to bend over as far. It collapses for easy storage and transport. Super-sharp bronze forged hook with wide gap for sure hooking.

MINNOW NET

Part No. MN-1



White Mesh Net

This nylon Minnow Net is ideal for "dipping" your minnows from your bucket or pail.



Heavy Duty Deep Well Minnow Nets

Part No. Part No. Part No.

MNH-1Y MNH-1O MNH-1B
 Yellow Color Mesh Orange Color Mesh Black Color Mesh

BULK
 480 per Master Case

ASSORTED HEAVY DUTY MINNOW NETS

Neon Orange
 Neon Blue
 Neon Yellow

Part No. MNH-1A

Priced per each

FLOATING MINNOW NET

Part No. FMN-1



White Mesh Net

No more wet, cold hands while trying to retrieve a minnow net that slides to the bottom of the pail. HT's new floating minnow net suspends the handle above the surface of the water, helping the angler get bait more efficiently.

Part No. FMN-1Y

Yellow Meshed Deep Well Net w/ Float



HEAVY DUTY FLOATING MINNOW NET

HT's floating minnow net suspends the handle above the surface of the water, helping the angler get bait more efficiently.

Wooden Baitwell Net



Part No.	Net Specs	Net Color	Hoop Size	Handle Length	Handle Material
<u>BWN-18W</u>	PE	Orange	9" x 11"	17"	Wooden



Handle 10" Long!

Hoop Size 5" x 6"

White Meshed Jumbo Sized Net

JUMBO MINNOW NET

Jumbo Minnow Net has a jumbo sized white mesh net and heavy duty coated handle.

Part No. MN-1B

Small Baitwell Nets



BWN-20 Pictured Great Baitwell Net!

Part No.	Net Specs	Net Color	Hoop Size	Handle Length	Handle Material
<u>BWN-10</u>	PE	Black	5" x 6"	14"	Solid Glass
<u>BWN-20</u>	PE	Black	8" x 10"	18"	Solid Glass

PLASTIC MINNOW SCOOP

Part No. PM-1



With Hook Disgorger

TIP-UP RIGS



HT 
WWW.HTENT.COM™

BAIT SAFE BAIT CONTAINERS

Rounded Inside Corners Protect Bait !

Part No. HCBC-5 5 Inch Indestructible Bait Container	Part No. HCBC-3 3 Inch Indestructible Bait Container
--	--



HOT RIGS

Part No. HTR-2	Description #2 Size Treble Hooks
HTR-4	#4 Size Treble Hooks
HTR-6	#6 Size Treble Hooks

These premium rigs come with sure point laser sharp premium blood red treble hooks. Each rig is pull tested to ensure a positive grip crimp for securing each hook.

These rigs come in a clam shell style package like our WR and PT tip-up rigs.



POLAR STINGER HOOKS



Two per Package

Part No.	Description
STH-2R	2" Long w/ Blood Red Treble Hook
STH-3R	3" Long w/ Blood Red Treble Hook
STH-2B	2" Long w/ Bronze Treble Hook
STH-3B	3" Long w/ Bronze Treble Hook
SSH-2B	2" Long w/ Barbed Bronze Straight Shank Hook
SSH-3B	3" Long w/ Barbed Bronze Straight Shank Hook

SPREADER RIGS

Part No. SRB-2 SRB-3

One per Package

Description

- 2-way spreader w/ spinner & beads
- 3-way spreader w/ spinner & beads



WALLEYE RIGS

Part No. WR-6	#6 Treble Hook
Part No. WR-8	#8 Treble Hook
Part No. WR-10	#10 Treble Hook



PIKE RIGS

Part No. PT-1/0	#1/0 Treble Hook
Part No. PT-2	#2 Treble Hook
Part No. PT-4	#4 Treble Hook

HT Tip-Up Rigs are equipped with a two-tone fluorescent yellow/orange painted blade and are made with super strong braided wire leaders. The Walleye rigs use 8# test leader and the Pike rigs are 27# test leaders.

Dual Hook Quick Strike Rigs



Part No. QSR-6	Part No. QSR-4
#6 Treble Hook	#4 Treble Hook

HT Quick Strike Rigs are equipped with two two-tone fluorescent blades and are made with super strong braided wire leaders. The rigs use 27# test leader, #4 or #6 single slide-action front treble hook, and #4 fixed position treble hook. 1 rig/pack

Wire Leaders



20# Test Line - 3 per Pkg Standard - Clear	30# Test Line - 3 per Pkg Standard - Clear
WL-620-3 6"	WL-630-3 6"
WL-920-3 9"	WL-930-3 9"
WL-1220-3 12"	WL-1230-3 12"

20# Test Line - 12 per Pkg Standard - Clear	30# Test Line - 12 per Pkg Standard - Clear
WL-620-12 6"	WL-630-12 6"
WL-920-12 9"	WL-930-12 9"
WL-1220-12 12"	WL-1230-12 12"



20# Test Line - 3 per Pkg Blood Red Color	30# Test Line - 3 per Pkg Blood Red Color
WLBR-620-3 6"	WLBR-630-3 6"
WLBR-920-3 9"	WLBR-930-3 9"
WLBR-1220-3 12"	WLBR-1230-3 12"



Game Fish BRAIDED WIRE RIGS

Part No. HW-GAMRIG-6X Hook Size #6	Part No. HW-GAMRIG-8X Hook Size #8
Part No. HW-GAMRIG-10X Hook Size #10	



SPRING BOBBERS



HT 
 WWW.HTENT.COM™

Ultra-light spring action detects the slightest bite. Soft "SCREW SECURE" mounting system that fits All rod tip-tops. Easily removes from rod tip-top when finished fishing.



SLAB STOPPER SPRING BOBBERS

Part No. **STB-3** Three Unique Sizes per pkg that Fit All Ice Combos!

Part No. **STB-2M** Two Micro Size per pkg

Little Jigger SPRING BOBBERS

FLUORESCENT ORANGE

Shrink Tube Mounting System

Part No. **SBF-2**

2 Bobbers & 2 Tubes

An extremely sensitive, flat, Spring-Steel Bobber that attaches easily to most Jig Poles. Instructions for attachment are included in



Little Jigger FLUORESCENT ORANGE SPRING BOBBERS



Part No. **SBF-1S** with Snap 1/pkg
SBF-2S with Snap 2/pkg

An extremely sensitive, flat, Spring-Steel Bobber that attaches easily to most Jig Poles. Instructions for attachment are included in package.

Little Jigger



FLUORESCENT ORANGE

SLAB MASTER SPRING BOBBERS



Two Panfish Ultra-Sensitive Models

- Ultra-sensitive coil spring design
- Fully adjustable soft rubber "SNAP-ON" system
- Easily attaches to any sized rod tip
- Easily detaches at "end-of-day"

Part No. **SLS-2**

One MicroTip
 One Large Tip
 Per Pkg

FLUORESCENT! MÄRMOOSKÄ SPRING BOBBERS



Part No. **MSB-2**



The Marmoska spring bobber originally used in Siberia is an extremely sensitive, flat, spring-steel bobber. Easily attaches to most ice rods with the "soft rubber" snap system. 2 per package.

Little Jigger "Big-Eye" SPRING BOBBER



Part No. **BE-2**
 2/Pkg



- Ultra sensitive spring wire
- "Big Eye" for E-Z ice-out
- Neon color for bite detection
- Easily mounts to any ice rod
- Multiple tension settings for different weighted bait

Little Jigger FLUORESCENT SUPER SENSITIVE SPRING BOBBERS

Part No. **SSB-1** 1/Bag
SSB-2 2/Bag

Shrink Tube Mounting System



A "super-sensitive", custom-designed, coil spring bobber that attaches easily to the tip of any jig pole. Blaze orange tip! Instructions for attachment are included.

SLAB STOPPER FX SPRING BOBBER

Part No. **SFMB-2**

Slides to Reduce Sensitivity



- Hi-Viz bright orange large eyelet for easy bite direction
- Special tapered soft foam easily inserts into most rod tips
- Ultra sensitive flat stainless steel slides in & out to create multiple bite sensitivity settings
- Set at a shorter length when using larger bait or tungsten jigs

Little Jigger
NIGHT STAR
 SPRING BOBBER



- Ultra bright red led light to detect all bites
- Universal soft rubber snap attachment system
- Includes standard br-435 lithium battery
- Superior sensitivity for a higher catch rate

Part No. LJNS-1

LITTLE JIGGER
BOBBER
 THREADER

Part No. SBT-2



Easily Thread Fishing Line through Coil Spring Bobbers

Little Jigger
SLAB SLAYER
 Spring Bobber



- Ultra sensitive wire system
- Clip-on snap attaches to most rod
- Detects the slightest bite

Part No. SSB-10

Little Jigger
CLIP-ON COIL
 SPRING BOBBERS

Glow-in-the-Dark



NEW SOFT RUBBER SNAP

Part No. CCB-2
 2/Bag

A "super-sensitive", custom-designed, Coil Spring Bobber that attaches easily to the Tip of any Jig Pole with a "Soft Rubber" snap feature. Blaze Glow-in-the-Dark Orange Tip!

Little Jigger
Balsa Micro Floats

Part No. BWS-2 Pkg Includes 1 each
 5/16 x 7/8 long
 1/2 x 1 1/4 long

Slotted Teardrop



These genuine balsa floats are super-sensitive, specially tapered body designs that create next to no resistance to biting fish. Packaged 2 per card one of each size.

Little Jigger
Balsa Slip Floats

Part No. BSF-2 Pkg Includes
 1 ea. 9/16"
 1 ea. 5/8"

Balsa Lite Bite



These genuine balsa floats are super-sensitive, specially tapered body designs that create next to no resistance to biting fish. Fixed float designs are attached using slip-on silicone sleeves, included. Packaged 2 per card one of each size.

Little Jigger
TEARDROP w/slit
STYROFLOATS

TWO-TONE FLUORESCENT



PART NO.	SIZES	COLORS
<u>STF-2T</u>	1/2"	Two-Tone
<u>STF-3T</u>	5/8"	Two-Tone

Little Jigger
Sponge Floats

Part No. SF-6 Specs
 1/2" - 6/pkg



These Bobbers are made of squeezable Sponge Rubber that is virtually indestructible. Bobbers thread on line with "pick" for sure positioning.



Little Jigger **SURE STOP** Line Stoppers



Part No. LS-3 Line Test 4-8#
LS-4 8-12#

Can be slid over your line while using slip bobbers, or used as an accurate "depthmarker" while jigging. 1 per package (15 Stoppers)

Little Jigger Bobber Stops

Part No. BRS-3 6 per pack
BRS-100 100 per pack



ULTRA-GLOW Light Sticks



Part No.	Color	Size
<u>UG-2</u> 2 sticks per package	Green	4.5 x 38 mm
<u>UG-7</u> 1 sticks per package	Green	7.5 x 75 mm

ULTRA-GLOW lightsticks can be used on all tip-ups and summer rods. "Lightstick" is activated by snapping, bending and shaking it. After it is activated, the lightstick turns into a glowing green color which lasts for 12 hours.



Counter Top Displayer
Priced by each, sold in multiples of 50

Part No.	Color	Size	100 sticks two/foil packs	50 foil packs
<u>UG-2B</u>	Green	4.5 x 38 mm	100 sticks	50 foil packs
<u>UG-7B</u>	Green	7.5 x 75 mm	50 sticks	50 foil packs



THERMAL FOAM HOLE COVER Part No. THC-1

HT's new THERMAL HOLE COVER works ideally with any tip-up! Simply slip the insulated foam material around the center tube or crossbar to prevent snow and light from entering the hole. The black material also absorbs sunlight and the thermal energy of the water to prevent the hole from freezing. Also included is HT's Freeze Proof tube, which prevents the Windlass from freezing up, even on the coldest days!



BLU-LUBE LUBRICANT

Special Anti-Freeze Formula

2 oz. Bottle
Part No. BL-2



Part No. BL-25
(4 oz.)



Special anti-freeze lube for Tip-Ups, Reels and Compound Bow Bearings. The lube remains soft in reels for fishing in late Fall and cold weather, but remains in gears during hot summer days. Great for Reel Repair Shops. The lube is odorless and ideal for use on Compound Bow Bearings. Comes in handy squeeze bottles.

All Season Bells

w/ Lite Stick Holder

Part No. TBH-1



HT's popular TIP-UP BELLS just got even better! Now you can add HT's ultra glow light sticks to the bells for even greater visibility. Comes with a 4.5 x 39 mm lightstick. (UG-2)

ALL PURPOSE FISHING GLOW BELLS with Lightstick Holder

The HT Glow Bells easily attach to any tip-up flag wire. When the fish hits, the bells and the fluorescent glow alert you to your tripped flag! Uses 4.5 x 39 mm lightstick.



Part No. LFB-1
1 per pkg

Part No. LFB-2
2 per pkg

Part No. LFB-100
100 per pkg



TIP-UP SPOOL

200 ft. Capacity Spool

Part No. **TU-2** Packaged

Part No. **TU-2B** Bulk per Dozen



A multi-purpose spool that can be used on both wind and underwater tip-ups. Made of virtually indestructible material that withstands cold temperatures.

JUMBO TIP-UP SPOOL



Part No. **TU-8** Packaged

TU-8B Bulk

1500 ft. capacity spool
Price by Dozen

A multi-purpose spool that can be used on underwater tip-ups. Made of virtually indestructible material that withstands cold temperatures.



500 ft. Capacity Spool

LARGE TIP-UP SPOOL

Part No. **TU-6** Packaged

TU-6B Bulk Price by Dozen

A multi-purpose spool that can be used on both wind and underwater tip-ups. Made of virtually indestructible material that withstands cold temperatures.

TELESCOPIC TIP-UP FLAG EXTENSION

Extends 32" High
1 per pkg



- This product is sure to attract every ice fisherman!
- Easily seen when fishing in deep snow
- Stands tall as a Tip-Up marker in the snow.
- Alerts snowmobilers and other vehicle operators to the presence of your tip-ups.
- Works with all PTE and PTT Polar Therm hole cover tip ups by HT. May work for other brands as well

Part No. **FAA-1**

TIP-UP "QUICK SPOOLING" CORDLESS DRILL ADAPTER

- Fits any cordless drill
- Unit slips over top of tip-up mechanism and is secured over trip shaft of "underwater" style tip-ups
- Spins tip-up tube mechanism to spool tip-up line quickly and effortlessly!



Part No. **QSA-50**

TIP-UP FLAG STEEL

Part No. **TU-4**

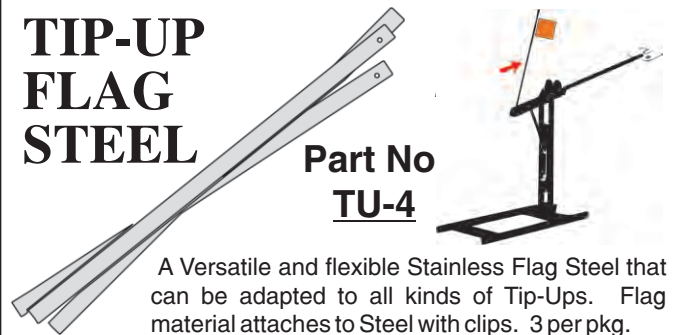

A Versatile and flexible Stainless Flag Steel that can be adapted to all kinds of Tip-Ups. Flag material attaches to Steel with clips. 3 per pkg.



TIP-UP FLAGS

Part No. **TU-5**
3"x3" Orange

Tip-Up Flags can be used on all Tip-Ups. Material is made of a durable, weather-resistant, rip-proof, vinyl-coated material.

ALL-SEASON LINE HOLDER



Part No. **LK-20**

The best way to keep your fishing line from "unreeling." Snaps easily on and off Tip-Up Spools to keep line in place. A handle makes the "lineholder" easy to grasp. Made of lightweight polypropylene so it floats. Fluorescent yellow color makes it hard to lose. 2 per package.

1 1/2" Diameter
Also Works Well For Your Summer Spinning Reels

TIP-UP LINEMARKERS

1/2" Dia.

Used as a "marker" on the line, not as a float. With Linemarkers, it is easy to re-set your line after a fish bites.

Part No. **TULM-6**
6 / Pkg.

Part No. **B-1** Priced per 100
Bulk



Tip up Flag Assembly Replacement

Part No. **FA-1**
1/pkg

- Works great on all HT branded PTU Polar Tip ups
- 16" plus long
- Hi-Vis pennant flag
- Super strong flag wire that will not kink or bend





Shelter/Dock Rod Holder

Part No. **SDH-100**

- Pedestal comes with 4 holes and 4 screws for easy mounting
- Adjusts to any angle for your rod combo
- Works for any rod handle size



Wire Rod Holder

Part No. **WRH-1**

HT now offers a method for holding that second jig rod securely, yet the rod is still easily accessible when a fish strikes.

Clamp-On Bucket Rod Holder

Part No. **RBH-100**



- Universal clamp that works for 5/6 gallon buckets
- Adjusts to any angle for your rod combo
- Works for any rod handle size



Wire Rod Holder

Part No. **WRH-1T**

Combo Not included

- Extra height for easy reaching of your rod combo—15 3/4" high
- Steady base for non tipping

IceMaster Folding Rod Holder

The Ice Master Folding Rod Holder conveniently folds to fit easily into a pail yet sturdy enough to hold any ice rod combo.



Part No. **IFH-1**

Combo Not included

COILED ICE ROD HOLDER

The Coiled Ice Rod Holder has been specially design to easily un-fold for quick set-up. Holds all types of rod/reel combos. Collapses to easily fit into any fishing bucket.

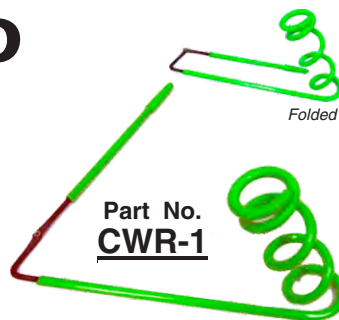

Part No. **CWR-1**

Power Ice ROD HOLDER

- 10 Inch screw-down ice rod holder
- Easily turns into the ice for secure mounting
- Keeps rod & reel out of slush

Part No. **PIRH-1**

Little Jigger Rod Stand

Part No. **LJR-100**

- Holds combos securely
- Lightweight



Combo Not Included

Rockin' Rod Holder

Part No. **RRH-10**

- Balanced "Tip-Down" style rod holder
- Secures your combo while allowing easy access to the combo to quickly set the hook!



Wind Jigger Rod Holder

- Jigs your rod combo with the slightest breeze
- 3 different angle settings
- Ultra steady base system
- Universal for any rod
- Folds up compact for easy transport and storage
- Super strong **Ultra-Flex Wind Waver** steel



Part No.
WJRH-50

Folded Down

LIFT N' HOOK Rod Holder

- Folds for easy portability & storage
- Lightweight & strong
- When fish strikes, grab your rod and set the hook!
- Hands free fishing helps enjoy your fishing experience



Part No.
LNH-100

Combo Not Included

Pail Wire Rod Holder

Part No. **PWR-1**

HT now offers another unique method for holding that second jig rod securely, yet the rod is still easily accessible when a fish strikes. This holder attaches to the rim of almost any kind of pail. Made of the same quality material as the regular wire rod holder.



Bucket and Combo
Not Included

BUCKET MASTER Storage Organizer

- Easily clips onto bucket
- Keeps rods tangle-free
- Foam pad helps secure and protect

Part No.
BBM-1

BUCKET MASTER Rod Holder

- Easily clips onto bucket
- Holds rod combo securely
- Hands free fishing helps enjoy your fishing experience

Part No.
BBRH-1

Bucket and Combo
Not Included





Tip-Tops

Orders in Qtys of 12 Only



**BULK Priced
By The Dozen**

Part No.

TT-5.....No. 5 - 8mm ID Ring / 2.2mm ID Tube

BRB-TT.....Brim Rod Tip Top - 8mm ID Ring / 1.2mm ID Tube

Ice Rod Tip Top Assortment

2 of each
BRB-TT / TT-5 / TT-10

Part No.
TT-1A

Variety of Tip-Tops and Guides
Available - Contact Sales Rep for Details

Corkalon Handles w/ Rings



BULK Priced By The Dozen - Orders in Qtys of 12 Only

Lightweight corkalon

handle with black rings Part No. CH-1B

Genuine Cork Handle



BULK Priced By The Dozen - Orders in Qtys of 12 Only

Comes with a .161" diameter bore hole

Part No. GCH-1

Wood Jig Pole Handle



BULK Priced By The Dozen - Orders in Qtys of 12 Only

Deluxe hardwood ice rod handle

Part No. WH-1

Tubular 96% Graphite Blanks

BULK Priced By The Dozen

Part No.

DGB-24 24" DGB-31 31" DGB-39 39"

Orders in Qtys of 12 Only

Ultra-Flex Solid Graphite Blanks

BULK Priced By The Dozen

Part No.

Orders in Qtys of 12 Only

GB-24 24"

These special blanks are made of a Graphite and Fiberglass composition.

GB-31 31"

Use 2.6 mm tip top.

GB-39 39"

Variety of Bulk Blanks Available Contact Sales Rep for Details

Handle Assemblies



Assembled Handle

**BULK Priced
By The Dozen**



Each Kit Contains All Components Shown

Orders in Qtys of 12 Only
Part No. TGOBH-125S



Assembled Handle



Each Kit Contains All Components Shown

Orders in Qtys of 12 Only
Part No. ILCH-1

Super Light Action Rod Blanks

BULK Priced By The Dozen

Part No.

SLUB-18 18" SLUB-36 36"

SLUB-24 24" SLUB-48 48"

SLUB-30 30"

Ultra Fast Action!!

Orders in Qtys of 12 Only Use 1.2 mm ID Tip Top

Ice Rod Blanks

BULK Priced By The Dozen

White Solid Fiberglass

Part No.

B-14 14"

B-21 21"

Use 2.2 mm ID Tip Top

Custom Ultralight Brim Rod Blank
Black with Orange Tip.

Part No.

BRB-22 22"

BRB-31 31"

BRB-36 36"

Orders in Qtys of 12 Only Use 1.2 mm ID Tip Top

ICE SCENTZ

PREMIUM JAR BAITS

- Bio friendly
- Scented to catch more fish
- Lifelike appearance
- Fish candy capsules can be strung onto any line or rig above your hook or lure
- Great for jigging or tip-up fishing

Merchandised On Shelf



Merchandised On Peg Hooks



72 PC LURE ASSORTMENT BOXES



Part No. HTA-72
HT Lure



Part No. JAWG-72
Jig-A-Whopper Gamefish



Part No. JAWP-72
Jig-A-Whopper Panfish



Part No. MTJA-72
Marmooska Tungsten



Part No. MJA-72
Marmooska

HT Fish Eye Lure Kit

- 3 each white, green/chartreuse, and chartreuse fish eye lures
- 1 each 5/8" teardrop float
- 1 each depthfinder
- 2 each slab stopper spring bobbers



13
piece



Size 10 **Part No. FEK-1310**

HT Ice Ant Lure Kit

- 3 each orange, chartreuse, and green ice ant lures
- 1 each 5/8" teardrop float
- 1 each depthfinder
- 2 each slab stopper spring bobbers



13
piece



Size 12 **Part No. IAK-1312**

HT Helicopter Jig Lure Kit

- 3 each orange, chartreuse, and green helicopter jig lures
- 1 each 5/8" teardrop float
- 1 each depthfinder
- 2 each slab stopper spring bobbers



13
piece



Size 10 **Part No. HJK-1310**

HT Glow Grub Lure Kit

- 3 each orange, chartreuse, and white glow grub lures
- 1 each 5/8" teardrop float
- 1 each depthfinder
- 2 each slab stopper spring bobbers



13
piece



Size 12 **Part No. G GK-1312**

HT Lunar Lure Kit

- 3 each orange, chartreuse, and green lunar lures
- 1 each 5/8" teardrop float
- 1 each depthfinder
- 2 each slab stopper spring bobbers



13
piece



Size 10 **Part No. LLK-1310**

HT Predator Jig Lure Kit

- 3 each glow orange, glow pink, and glow green predator jigs
- 1 each 5/8" teardrop float
- 1 each depthfinder
- 2 each slab stopper spring bobbers



13
piece



Size 10 **Part No. PRK-1310**

HT HI-TECH FISHING GEAR™/MC Hardwater Tackle

Micro Jig ASSORTMENTS



Part No. **HW-ECK3STA8X**
Hook Size #8

Part No. **HW-ECK5MGLAX**
Hook Size #8

Part No. **HW-ECK58A-X**
Hook Size #8

Part No. **HW-ECK5MG10X**
Hook Size #10

Part No. **HW-ECK5GL10X**
Hook Size #10

Part No. **HW-ECK510A-X**
Hook Size #10

HT WWW.HTENT.COM™

HT Lure Assortments



Part No. **RCK-84A**
Rocker Jig
Size#8 4/pk

Part No. **RCK-104A**
Rocker Jig
Size#10 4/pk



Part No. **MNJ-124A**
Moon Jig
Size#12 4/pk



Part No. **TWK-84A**
Twinkle Jig
Size#8 4/pk



Part No. **BSY-104A**
Bullseye Jig
Size#10 4/pk

- These premium 4/pack jig assortments come with a ultra fine super sharp hook point with power to catch more fish
- Assortments come with the best colors available
- Custom designs that attract fish

Tom Gruenwald Signature Series

Panfish Kits

Tom Gruenwald, author and professional ice angler, endorses this professionally selected group of proven ice fishing lures -- Now conveniently packaged in these value packed kits!

All Kits are 6 per case



PART NO. PLK-10 10 piece Panfish Ice Fish'n Kit



PART NO. PGA-10 10 piece GLOW Panfish Ice Fish'n Kit



PART NO. PLK-8 8 piece Panfish Ice Fish'n Kit



PART NO. PIF-9 9 piece Panfish Ice Fish'n Kit

Tom Gruenwald Signature Series Lure Kits

Tom Gruenwald, author and professional ice angler, endorses this professionally selected group of proven ice fishing lures -- Now conveniently packaged in these value packed kits! Tom's "Hooked on Ice Fishing" book series is featured on page 24!

All Kits are 6 per case



Deluxe 13 piece Panfish Lure Kit

- 10 Ice Jigs
- 2 Balsa Floats
- 1 Depthfinder

PART NO. PLK-13



Deluxe 15 piece GLOW Panfish Lure Kit

- 15 Glow Panfish Lures

PART NO. PGA-15

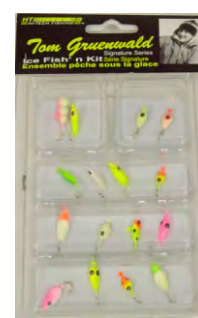

Deluxe 16 piece Ice Lure Assortment

- 16 Assorted Ice Lures

PART NO. PAJ-16

Avenger Lure Kit

"Your Complete Lure Kit"

HT's Avenger Lure Kit features ice fishing's hottest ice lures: swimming minnow, jiggling minnow, selection of blade baits, a jiggling spoon and variety of horizontal and vertical ice jigs. Makes a great addition to any ice angler's lure selection!

Part No. ALK-14

14 Assorted Lures per Kit
6 packs per case



Rocker Jig Lure Kit

- 3 each pink, chartreuse, and green rocker jig lures
- 1 each 5/8" teardrop float
- 1 each depthfinder
- 2 each slab stopper spring bobbers

13 Piece

Part No. RCKK-1312
Size 12



Slim Rat Lure Kit

- 3 each orange, chartreuse, and green slim rat lures
- 1 each 5/8" teardrop float
- 1 each depthfinder
- 2 each slab stopper spring bobbers

13 Piece

Part No. SRK-1310
Size 10





Complete 31 piece Ice Master Kit

HT's complete Ice Master tackle kit contains a variety of premium terminal tackle items:
10 assorted ice jigs, 2 Jet Jig swimming lures, 2 power minnow jigs, 2 alligator style clip depthfinders, a 7 piece assortment of premium balsa floats, plus a variety of slip bobber stops. Makes a practical ice fishing starter kit for the beginner or tackle box filler for the veteran!

Part No.
IMK-31

The Complete Ice Master Kit Includes:

- 7 assorted balsa floats
- 3 linestoppers
- 10 assorted ice lures
- 2 1/4 oz. jet jigs
- 2 power minnow lures
- 2 "alligator clip style" depthfinders
- 5 each assorted bronze hooks



HOT BITE LURES Enforcer Gamefish Spoon Lure Kit

Part No.
EGK-5 1/4 oz.

1 each of
5 colors

Blue/White
Green/White
Gold
Chartreuse/White
Silver/White

HT's Enforcer Walleye Spoon Kit features five premium quality jigging spoons in some of our most popular sizes and colors. Kit includes spare split rings and attractors for "change-ups," all in one convenient kit!



Panfish Kit GLOW!

Part No.
PKA-16
16 assorted
pieces per kit

Kit Includes

- 4 compartment plastic box
- 9 assorted glow panfish lures
- 2 medium size depth finders
- 2 balsa slip floats
- 1 ea. 1/2" easy ice out sponge float with peg
- Slip bobber knots with beads



Panfish Kit GLOW!

Part No.
GLK-1310
16 assorted
pieces per kit

Kit Includes

- 4 compartment plastic box
- 9 assorted glow panfish lures
- 2 medium size depth finders
- 2 balsa slip floats
- 1 ea. 1/2" easy ice out sponge float with peg
- Slip bobber knots with beads



Quick Strike Minnow Kit GLOW!

Part No. **QMS-5A**
5 assorted lures per kit



First Strike Minnows Kit GLOW!

Part No. **FS-5A**
5 assorted lures per kit

Marmooska **RUBY** Jig

2 / Pack Assorted

Part No.	Hook Size
<u>MJBR-8A</u>	#8
<u>MJBR-10A</u>	#10
<u>MJBR-12A</u>	#12

12 / Card Assorted

Part No.	Hook Size
<u>MJR-8A</u>	#8
<u>MJR-10A</u>	#10
<u>MJR-12A</u>	#12



- 2/pack **MJBR** Marmooska rubys get 1 chartreuse/orange colored jig and 1 chartreuse/green colored jig.
- 12/card assorted **MJR** Marmooska rubys get 3 each of the following colors chartreuse/green, chartreuse/orange, white glitter and blue/white.
- These jigs come with a custom cut glass style ruby red stone that attracts fish
- Premium ultra fine hook with a sharp power point system
- Premium custom horizontal jig with a slight angle that fish love

Marmooska TUNGSTEN

Marmooska TUNGSTEN EYEBALL Jig

Part No.	Hook Size
<u>MJEB-8A</u>	#8
<u>MJEB-10A</u>	#10
<u>MJEB-12A</u>	#12
<u>MJEB-14A</u>	#14



Two Jigs per Package

Marmooska TUNGSTEN DROPPER Jig

Part No.	Hook Size
<u>MJDJ-8A</u>	#8
<u>MJDJ-10A</u>	#10
<u>MJDJ-12A</u>	#12
<u>MJDJ-14A</u>	#14



Two Jigs per Package

Marmooska TUNGSTEN SHAD Jig

Part No.	Hook Size
<u>MJSD-8A</u>	#8
<u>MJSD-10A</u>	#10
<u>MJSD-12A</u>	#12
<u>MJSD-14A</u>	#14



Two Jigs per Package

- The revolutionaly marmooska design molded from premium quality tungsten material!
- Tungsten is denser than lead, so these jigs sink faster and get down to fish quickly
- Heavier tungsten material also provides increased jigging, improved presentation control and better sensitivity, plus shows up more clearly on sonar
- HT tungsten marmooska jigs feature premium quality, razor sharp hooks, several unique designs and sizes, plus premium paint finishes and coatings

SILVER

GOLD

Marmooska TUNGSTEN DANCER

Ice Jig

Part No.	Hook Size	Color
<u>MJDB-14G</u>	#14	Gold
<u>MJDB-14S</u>	#14	Silver
<u>MJDB-16G</u>	#16	Gold
<u>MJDB-16S</u>	#16	Silver

One per Package

Marmooska TUNGSTEN DELUXE

Ice Jig

Part No.	Hook Size
<u>MJDXB-8A</u>	#8
<u>MJDXB-10A</u>	#10
<u>MJDXB-12A</u>	#12

Two Jigs per Package

Marmooska TUNGSTEN DIAMOND

Ice Jig

Part No.	Hook Size
<u>MJDIB-8A</u>	#8
<u>MJDIB-10A</u>	#10
<u>MJDIB-12A</u>	#12
<u>MJDIB-14A</u>	#14

Two Jigs per Package

Marmooska TUNGSTEN GEM

Ice Jig

Part No.	Hook Size
<u>MJGB-8A</u>	#8
<u>MJGB-10A</u>	#10
<u>MJGB-12A</u>	#12
<u>MJGB-14A</u>	#14

Two Jigs per Package

Marmooska TUNGSTEN LUNAR

Ice Jig

Part No.	Hook Size
<u>MJLN-8A</u>	#8
<u>MJLN-10A</u>	#10
<u>MJLN-12A</u>	#12
<u>MJLN-14A</u>	#14

Two Jigs per Package

FOUR PACK Tiger Willow Ice Jig Assortment



Part No.
TW-4A

Hook Size
#2

Each Assortment
includes Four Lures
- One of Four Different Colors

- 1 each - Green/Chartreuse
- 1 each - Orange/Chartreuse
- 1 each - Silver/Purple
- 1 each - Silver/Blue

FOUR PACK Lazer Rocker Minnow Ice Lure Assortment



Part No.	Weight
LRM-418A	1/8 oz
LRM-414A	1/4 oz

Each Assortment
includes Four Lures
- One of Four Different Colors

- 1 each - Orange/Chartreuse
- 1 each - Gold/Orange
- 1 each - Silver Lime
- 1 each - Green Perch Glow

FOUR PACK Hornet Grub Ice Jig Assortment



Part No.	Weight/Hook Size
HGJ-416	1/16 oz / #8
HGJ-432	1/32 oz / #10
HGJ-464	1/64 oz / #12

Each Assortment
Includes Four Lures
- One of Four Different Colors

- 1 each - Green/Chartreuse
- 1 each - Orange/Chartreuse
- 1 each - White/Chartreuse
- 1 each - Blue/Pink

FOUR PACK Hawger Spoon Silver Ice Lure Assortment



Part No.	Weight
HSK-418	1/8 oz
HSK-414	1/4 oz

Each Assortment
Includes Four Lures
- One of Four Different Colors

- 1 each - Pearl Glow
- 1 each - Chartreuse Prism
- 1 each - Silver Prism
- 1 each - Blue Prism

MÄRMOOSKÄ

GLOW-IN-THE-DARK !

In Europe, the word is spelled "Mormyska". These unique jigs are used almost exclusively by the Swedish, Finnish, and Russian champions - a testament to their effectiveness. HT has chosen to make these highly effective lures available to the North American Ice Angler!



Bright Colors



Green/Chartreuse



Chartreuse/Orange

Two Lures per Bubble Pack

Bright Bubble Packs include:
One Chartreuse/Orange Jig
One Chartreuse/Green Jig

MJB-6B	#6	Bright
MJB-8B	#8	Bright
MJB-10B	#10	Bright
MJB-12B	#12	Bright
MJB-14B	#14	Bright

MÄRMOOSKÄ

SINGLE COLOR BUBBLE CARDS

In Europe, the word is spelled "Mormyska". These unique jigs are used almost exclusively by the Swedish, Finnish, and Russian champions - a testament to their effectiveness. HT has chosen to make these highly effective lures available to the North American Ice Angler!

Bright Colors



Pink/White



Zebra Chartreuse



Green/Chartreuse



Zebra Glow White



Orange/Chartreuse



Zebra Blue



Glow Purple

MJB-8PW #8 Pink/White

MJB-10PW #10 Pink/White

MJB-12PW #12 Pink/White

MJB-14PW #14 Pink/White

MJB-8OC #8 Orange/Chartreuse

MJB-10OC #10 Orange/Chartreuse

MJB-12OC #12 Orange/Chartreuse

MJB-14OC #14 Orange/Chartreuse

MJB-8PUR #8 Glow Purple

MJB-10PUR #10 Glow Purple

MJB-12PUR #12 Glow Purple

MJB-14PUR #14 Glow Purple

MJB-8ZW #8 Zebra Glow White

MJB-10ZW #10 Zebra Glow White

MJB-12ZW #12 Zebra Glow White

MJB-14ZW #14 Zebra Glow White

MJB-8GC #8 Green/Chartreuse

MJB-10GC #10 Green/Chartreuse

MJB-12GC #12 Green/Chartreuse

MJB-14GC #14 Green/Chartreuse

MJB-8ZC #8 Zebra Chartreuse

MJB-10ZC #10 Zebra Chartreuse

MJB-12ZC #12 Zebra Chartreuse

MJB-14ZC #14 Zebra Chartreuse

MJB-8ZB #8 Zebra Blue

MJB-10ZB #10 Zebra Blue

MJB-12ZB #12 Zebra Blue

MJB-14ZB #14 Zebra Blue

Two Lures per Bubble Pack

MÄRMOOSKÄ

GLOW-IN-THE-DARK !

Bright Assorted Cards

are 3 each of Bright Colors
Pink/White, Orange/Black,
Chart./Lt. Green, Chart./Orange

Assorted
12 per
Card
Lures

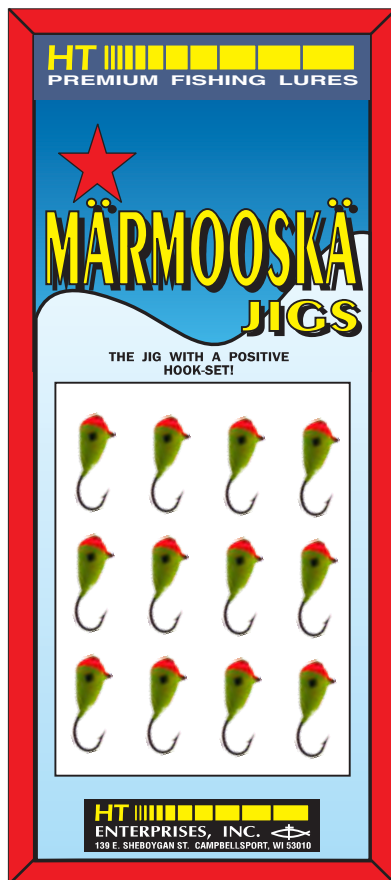

MJ-8B #8 *Bright Assorted*
MJ-10B #10 *Bright Assorted*
MJ-12B #12 *Bright Assorted*
MJ-14B #14 *Bright Assorted*

MJ-8PUR #8 *Glow Purple*
MJ-10PUR #10 *Glow Purple*
MJ-12PUR #12 *Glow Purple*
MJ-14PUR #14 *Glow Purple*

MJ-8PW #8 *Pink/White*
MJ-10PW #10 *Pink/White*
MJ-12PW #12 *Pink/White*
MJ-14PW #14 *Pink/White*

MJ-8ZB #8 *Zebra Blue*
MJ-10ZB #10 *Zebra Blue*
MJ-12ZB #12 *Zebra Blue*
MJ-14ZB #14 *Zebra Blue*

MJ-8OC #8 *Orange/Chartreuse*
MJ-10OC #10 *Orange/Chartreuse*
MJ-12OC #12 *Orange/Chartreuse*
MJ-14OC #14 *Orange/Chartreuse*

MJ-8ZW #8 *Zebra Glow White*
MJ-10ZW #10 *Zebra Glow White*
MJ-12ZW #12 *Zebra Glow White*
MJ-14ZW #14 *Zebra Glow White*

MJ-8GC #8 *Green/Chartreuse*
MJ-10GC #10 *Green/Chartreuse*
MJ-12GC #12 *Green/Chartreuse*
MJ-14GC #14 *Green/Chartreuse*

MJ-8ZC #8 *Zebra/Chartreuse*
MJ-10ZC #10 *Zebra/Chartreuse*
MJ-12ZC #12 *Zebra/Chartreuse*
MJ-14ZC #14 *Zebra/Chartreuse*

Priced By
Card Only

Single Color - 12 per Card Lures

Optimax

Glow Treble Hooks

HT's **Optimax** treble hooks feature a variety of painted glow colors. Can be used as part of a standard tip-up rig or custom designed "quick strike" rig, or may be used as a replacement style hook on virtually any jigging lure. 6 pcs./package.

Each Package contains
2 of Each Color
 Glow Chartreuse
 Glow Pink
 Glow Orange

Part No.
OPT-6 *Size 6*
OPT-8 *Size 8*
OPT-10 *Size 10*

Six Glow Hooks per Bubble Pack



Glow Chartreuse



Glow Orange



Glow Pink

GOLDEN LITE

ICE LURES



HT's **GOLDEN LITES** have an attracting quality all fish are inherently triggered by! As sunlight glimmers off the special glitter, it creates a fish-attracting flash. HT's researchers have found that winter and fussy summer fish often examine lures closely, ignoring anything that isn't the right size, shape, or color. HT's **GOLDEN LITES** attract even the toughest to catch!



Glow Green

Glow Chartreuse

Glow Orange

Three Lures per Bubble Pack

Part No.
GLB-10 *Size 10*
GLB-12 *Size 12*

Colors

One Glow Orange
 One Glow Chartreuse
 One Glow Green

Twelve Lures per Display Card

Part No.
GL-10A *Size 10*
GL-12A *Size 12*

Colors

Four Glow Orange
 Four Glow Chartreuse
 Four Glow Green

ICE ANTS

THE ANT FISH CAN'T RESIST!!!



RESIST!!!

HT's **ICE ANTS** are proven highly effective for both winter and summer. The tantalizing action produced by the soft rubber legs is more than fish can resist! When jigged up and down by the angler or by wave action created from a bobber or float clipped just above it, the HT's **ICE ANT** accurately simulates the motion of zooplankton, an important part of the panfish diet.



Glow Chartreuse



Glow Orange

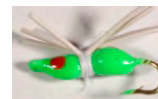

Glow Lime Green

Three Lures per Bubble Pack

Part No.
IAB-10 *Size 10*
IAB-12 *Size 12*

Colors

One Glow Orange
 One Glow Chartreuse
 One Glow Lime Green

Twelve Lures per Display Card

Part No.
IA-10A *Size 10*
IA-12A *Size 12*

Colors

Four Glow Orange
 Four Glow Chartreuse
 Four Glow Lime Green

FISH EYE JIGS



Studies have indicated that when gamefish strike their prey often the eye is the item they focus their attack on. **Hot Bite FISH EYE LURES** simply enhance this natural attracting feature and will increase your catch! In fact, some research shows that **Hot Bite FISH EYE LURES** will fool actively feeding fish two to three times that of similar lures. This lure is great for summer or winter fishing.



Glow Orange/
Chartreuse



Glow White



Glow Green/
Chartreuse

Three Lures per Bubble Pack
Colors
One Glow Orange/Chartreuse, One Glow White
& One Glow Green/Chartreuse

Part No.
FEJB-6 Size 6
FEJB-8 Size 8
FEJB-10 Size 10

Twelve Lures per Display Card
Colors
Four Glow Orange/Chartreuse, Four Glow White
& Four Glow Green/Chartreuse

Part No.
FE-6A Size 6
FE-8A Size 8
FE-10A Size 10

LUNAR LURES



Hot Bite LUNAR LURES are proven highly effective, both summer and winter. The subtle "Lunar Glow" helps fish find your lure in conditions where they can't see well, such as dark or stained water environments or at night.

Hot Bite LUNAR LURES are sold as traditional teardrop lures with the advantage of its unique glow feature.



Glow Green



Glow Orange



Glow Chartreuse

Three Lures per Bubble Pack
Colors
One Glow Orange, One Glow Green
& One Glow Chartreuse

Part No.
LLB-6 Size 6
LLB-8 Size 8
LLB-10 Size 10
LLB-12 Size 12

Twelve Lures per Display Card
Colors
Four Glow Orange, Four Glow Green
& Four Glow Chartreuse

Part No.
LL-6A Size 6
LL-8A Size 8
LL-10A Size 10
LL-12A Size 12

SLIM RAT ICE JIGS



Hot Bite's custom designed Slim Rat Jigs feature light, precision balanced heads and an exclusive, highly durable "tight-fit" soft bodied tube tails. This combination results in an extremely small profile, slow falling bait that helps trigger even the fussiest winter fish. Works especially well when tipped with tiny maggots or grubs.



Glow Pink



Glow Orange



Glow Chartreuse

Three Lures per Bubble Pack Colors

One Glow Orange, One Glow Pink & One Glow Chartreuse

Part No.

SRB-8 Size 8

SRB-10 Size 10

SRB-12 Size 12

Twelve Lures per Display Card Colors

Four Glow Orange, Four Glow Pink & Four Glow Chartreuse

Part No.

SR-8A Size 8

SR-10A Size 10

SR-12A Size 12

ICE MITES JIGS



HT's Ice Mite Jigs are a thin-bodied, lightweight, slow falling horizontal jig with a long hook shaft, which helps accommodate a variety of baits and present them in a natural, horizontal position. An excellent choice when fishing shallow water pan fish!



Glow Orange



Glow Green



Glow Rust

Three Lures per Bubble Pack Colors

One Glow Orange, One Glow Green & One Glow Rust

Part No.

IMB-10 Size 10

Twelve Lures per Display Card Colors

Four Glow Orange, Four Glow Green & Four Glow Rust

Part No.

IM-10A Size 10



ROCKER JIGS

Force **ROCKER JIGS** are proven highly effective . . . Winter or Summer. The unique "rocking action" of Force **ROCKER JIGS** works wonders for all gamefish, particularly when vertically jigged for crappies, white bass, bluegills and perch. When fishing with the **WINDLASS TIP-UP, ROCKER JIGS** produce an irresistible action for larger predators, such as northern or walleyes.



Three Jigs per Bubble Pack Colors

One Glow Pink, One Glow Blue & One Glow Chartreuse



Glow Chartreuse

Part No.

RCKB-6 Size 6

RCKB-8 Size 8

RCKB-10 Size 10

RCKB-12 Size 12



Glow Pink

Twelve Lures per Display Card

Part No.

RCK-6A Size 6

RCK-8A Size 8

RCK-10A Size 10

RCK-12A Size 12

Colors

Four Glow Pink

Four Glow Blue

Four Glow Chartreuse



Glow Blue

HELICOPTER JIG



Glow Orange



Glow Ghartrouse



Glow Lime Green



Three Jigs per Bubble Pack Colors

One Glow Orange, One Glow Lime Green & One Glow Chartreuse

Part No.

HJB-10 Size 10

Force now offers our famous teardrops in a new concept We've added a prop! We call' em **Helicopter Jigs**, and they' re deadly for all species of panfish. The prop provides a soft fluttering, sinking action that panfish cannot resist. These jigs are handcrafted and individually soldered to provide the ice fisherman with a quality jig.

Twelve Lures per Display Card

Part No.

HJ-10A Size 10

Colors

Four Glow Orange

Four Glow Lime Green

Four Glow Chartreuse

Glow Grub JIGS



Glow Chartreuse



Glow Orange



Glow White



Force **Glow Grub** lures feature a segmented body design that closely resembles a fishes natural forage, and the horizontal design allows precision bait presentation at any depth. Works best when tipped with a grub or minnow. Effective for all panfish and game fish.

Three Jigs per Bubble Pack

Colors

One Glow Orange, One Glow White & One Glow Chartreuse

Part No.

GGB-8 Size 8

GGB-10 Size 10

GGB-12 Size 12

Twelve Lures per Display Card

Part No.

GG-8A Size 8

GG-10A Size 10

GG-12A Size 12

Colors

Four Glow Orange

Four Glow White

Four Glow Chartreuse

Mousee JIGS

With Plastic Shrimp Tail!

Force **Mousee** jigs are a lightweight, super slow-falling vertical jig design featuring a soft plastic body with a long, vibrating "tail" that closely resembles a real "mousee" grub. Even the slightest, gentle jiggling motion causes the thin plastic "tail" to undulate in a natural motion that is irresistible to all panfish.

Glow White



Glow Chartreuse



Glow Orange



Colors

One Glow Orange One Glow White & One Glow Chartreuse

Three Jigs per Bubble Pack



Part No.

MEB-10 Size 10

Twelve Lures per Display Card

Part No.

ME-10A Size 10

Colors

Four Glow Orange

Four Glow White

Four Glow Chartreuse



Force Lures



HT  
WWW.HTENT.COM™

PREDATOR JIG

The Force Predator Jig is a slightly larger bodied vertical jig with a special shape that creates a slight “swimming” motion when lowered, and the heavier body remains balanced even when tipped with minnows or larger grubs. A great lure choice when fishing schooling or aggressive winter fish.

Three Jigs per Bubble Pack

Part No.

PRJ-8 Size 8 Hook

PRJ-10 Size 10 Hook

Colors

One Glow Pink, One Glow Orange
& One Glow Lime Green

Twelve Lures per Display Card

Part No.

PR-8A Size 8 Four Glow Pink

Four Glow Orange

PR-10A Size 10 Four Glow Lime Green

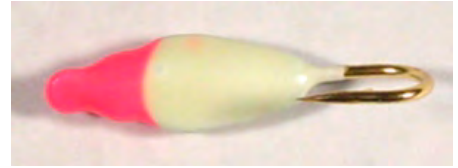

Glow Pink

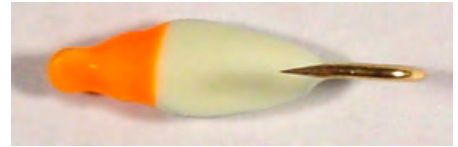

Glow Orange



Glow Lime Green

CHAIN RIG

HT's Chain Rigs might be one of ice fishing's best developments. A lightweight chain and snap allow this bait to be rigged and fished alone, but reign supreme as a dropper beneath virtually any type of jiggling minnow or spoon.

Contains

One Chain Rig with
#12 Single
Straight Shank

“Blood Red” Hook
and

One Chain Rig with
#12 Treble
“Blood Red”
Hook

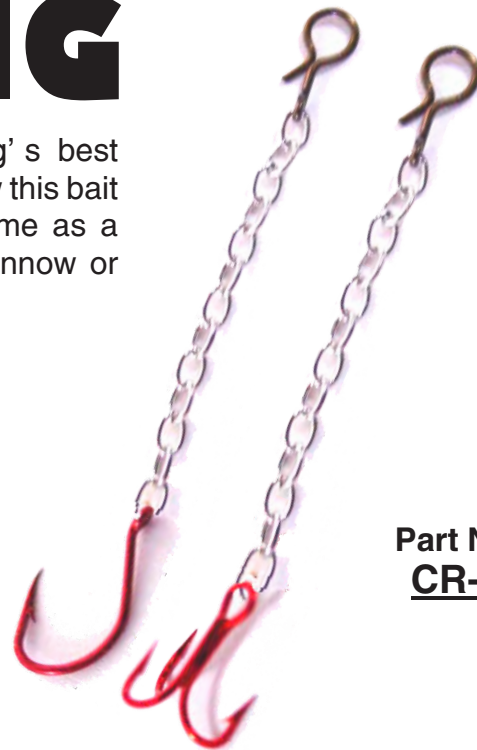

Part No.
CR-2

ORIGINAL  ORIGINAL
JIG-A-WHOPPER[®]

Patent# 4,891,900

JIG-A-WHOPPER[®]
HAWGER[®] SPOON RATTLE

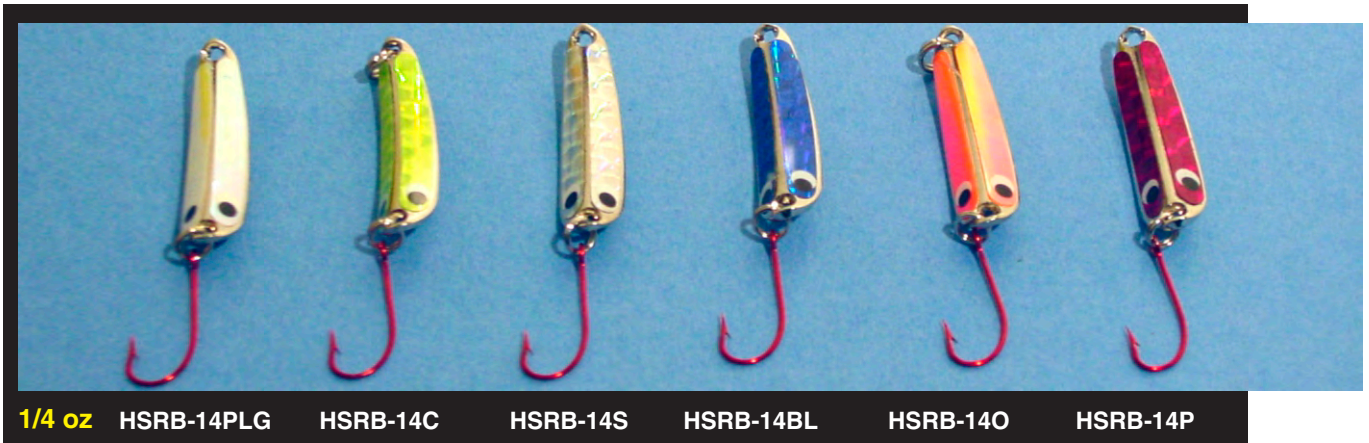

Color Key

PLG	Pearl Glow	BL	Blue Prism
C	Chartreuse Prism	O	Orange
S	Silver Prism	P	Purple Prism

**Above Part Numbers are
Blister Cards of 1 each**

ORIGINAL  ORIGINAL
JIG-A-WHOPPER®

Patent# 4,891,900

JIG-A-WHOPPER®
HAWGER® SPOON SILVER



1/4 oz HSB-14PLG HSB-14C HSB-14S HSB-14BL HSB-14O HSB-14P



1/8 oz HSB-18PLG HSB-18C HSB-18S HSB-18BL HSB-18O HSB-18P

Color Key

PLG	Pearl Glow	BL	Blue Prism
C	Chartreuse Prism	O	Orange
S	Silver Prism	P	Purple Prism

**Above Part Numbers are
Blister Cards of 1 each**

ORIGINAL  ORIGINAL
JIG-A-WHOPPER®

Patent# 4,891,900

JIG-A-WHOPPER®
LAZER ROCKER MINNOW®



1/4 oz LRB-14PPG LRB-14COG LRB-14GO LRB-14SL LRB-14WG LRB-14GPG



1/8 oz LRB-18PPG LRB-18COG LRB-18GO LRB-18SL LRB-18WG LRB-18GPG

Color Key

- PPGPurple Pink Glow
- COGChartreuse Orange Glow
- GOGold Orange
- SLSilver Lime
- WGWhite Glow
- GPGGreen Perch Glow

**Above Part Numbers are
Blister Cards of 1 each**

ORIGINAL ORIGINAL
JIG-A-WHOPPER®



Patent# D 408883

JIG-A-WHOPPER® ZEBRA JIGS

Part No. ZBB-10GPB #10 1 each of colors below
 Green, Pink, Black
ZBB-10OWC #10 Orange, White, Chartreuse

Three Lures per Blister Card

TIGER WILLOW SPOONS

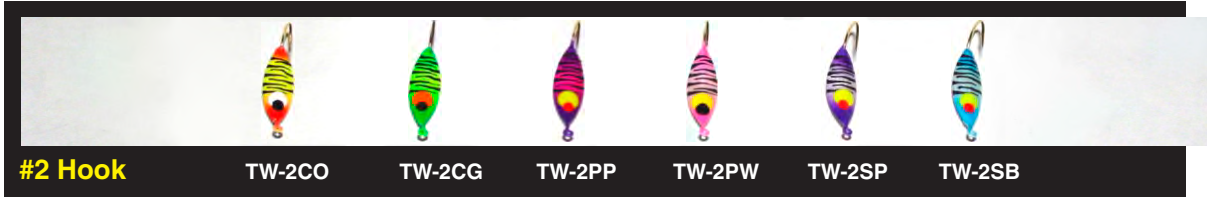

#2 Hook

TW-2CO TW-2CG TW-2PP TW-2PW TW-2SP TW-2SB

Above Part Numbers are Blister Pack ONLY - Two per Blister

Color Key

CO.....Chartreuse/Orange	PP.....Purple/Pink	SP.....Silver/Purple
CG.....Chartreuse/Green	PW.....Pink/White	SB.....Silver/Blue

JIG-A-WHOPPER® LURE KITS



GAMEFISH SPOON KIT

10 Piece Kit Includes:
 Hottest Jig-A-Whopper
 Spoons In One Kit !

Part No.
JWGK-10



PANFISH ASSORTMENT LURE KIT

18 Piece Kit Includes:
 Eighteen of the
 Hottest Panfish Lures
 in the Market Today !

Part No.
JWPK-18

PREMIUM HT GLOVES

Part No. **HT10-L** - LARGE

HT10-XL - EXTRA LARGE



- Premium lining inside to withstand the extreme temperatures
- A matted rubber inside grip on the fingers and palm area for a sure grip
- Adjustable strap by the wrist area to keep the cold air out and the warm air in
- Extra long cuff to go up past your wrist area to stay warm.
- A draw pull string also on the cuff to keep the cold air out



Full Finger Neoprene Gloves

Part No. **FN-1M** **FN-2L** **FN-3XL**
 Size **Medium** **Large** **X-Large**

Full fingered black neoprenes without the "cut or slit finger designs". Great for hunting, fishing, snowmobiling, skiing, or any other cold weather sport.

POLAR Mitts

"PREMIUM QUALITY from FINLAND"

The Polar Mitts are a new type of thermo mitt that offers the warmest and driest hand protection available for cold winter days. The outer shell is textured and waterproof for comfort and easy grasping. Liners Included

LARGE **X-LARGE**
 Part No. **GL-1** Part No. **GL-2**



POLAR Gloves

"PREMIUM QUALITY from FINLAND"

The Polar Glove offers the ultimate in hand protection. The outer shell is textured and waterproof for comfort and easy grasping. Works great for ice fishing, snowmobiling, skiing and window washing. Liners Included

LARGE **X-LARGE**
 Part No. **EF-1** Part No. **EF-2**



RESCUE Throw Bag

Part No. **RTB-100**

- High visibility throw bag can be thrown to person in the water up to 50' away
- 3/8" heavy duty hi visibility yellow braided nylon rope w/ strong loop for person being rescued to grasp
- Throw bag allows you to rescue person from a safe distance without entering the water



ALL PURPOSE

SAFETY CLEATS

- General Safety • Ice Fishing • Fly Fishing
- Construction • Marine

- Embedded serrated plates provide a positive traction on slippery surfaces including ice!
- Easily slips onto shoes and boots
- Quick on and off design
- Helps prevent injuries caused by falling
- Great for climbing steep banks and hills
- Easily stored anywhere / ready to use!



Part No. Shoes/Boots

SGT-0	4 - 7
SGT-1	8 - 10
SGT-2	11 - 13
SGT-3	14+
SGT-1D	8 - 10
SGT-2D	11 - 13
SGT-1SK	8 - 10
SGT-2SK	11 - 13



SGT-1D/-2D
Dump Bin Display
48 per Display

Mix or Match Sizes Available



SGT-1SK/-2SK
Sidekick Display
36 per Display

Mix or Match Sizes Available

These new cleats offer traction in combination with the serrated plates and studs for a sure grip.



Part No. Shoes/Boots

SGTS-0	4-7
SGTS-1	8-10
SGTS-2	11-13
SGTS-3	14+



PREMIUM

EZ-ON and OFF

Stud Cleats



- Elastic construction makes it easy to attach and remove from shoes & boots

ALL PURPOSE

Part No. **SHOES/BOOTS**
CC-1L SIZE 8-10.5

Part No. **SHOES/BOOTS**
CC-2XL SIZE 11+





HT ICE CLEATS

Quick On and Off Type Cleats



Part No. **ICN-10**

Ice cleats for safety, rubber strap with quick clip and release feature. 6 per Case.



HT ICE CLEATS

Buckle Type Cleats

Part No. **ICB-10**

Ice cleats for safety, "buckle up" feature for convenience.

Super Spike Treads

- Walking on hard snow or ice
- Sure footing on any surface
- Easy-On tough rubber material
- Hardened steel peg construction



SS-1LSK / -2XLSK
Sidekick Display

36 per Display
Mix or Match Sizes Available

- Part No.
- SS-0M** Boot/Shoe Size 5-7
 - SS-1L** Boot/Shoe Size 8-10
 - SS-2XL** Boot/Shoe Size 11-13
 - SS-3XXL** Boot/Shoe Size 14+



Sure Grip COIL CLEATS

Metal coil grippers on the heel add support and improved traction at the heel.

- Part No.
- SGC-1M** Medium Size - Boot/Shoe Size 5 to 9
 - SGC-2L** Large Size - Boot/Shoe Size 10 to 12
 - SGC-3XL** X-Large - Boot/Shoe Size 13+



Super Stud SANDAL CLEATS

- Part No.
- SCL-1** Medium Size - Boot/Shoe Size 8 to 10
 - SCL-2** Large Size - Boot/Shoe Size 10 to 12
 - SCL-3** X-Large - Boot/Shoe Size 13 +
 - SSR-36** Pack of 36 Replacement Studs



POLAR ICE CLAWS

The **ULTIMATE** Ice Cleat

- One size fits all
- Prevents slipping
- Rugged and durable
- E-Z On and Off

Part No. **PIC-10**



SURE GRIP SAFETY SPIKE ICE TREADS

- HT easy-on/easy-off sure grip safety spike ice cleats
- Lightweight - premium super flex silicone rubber material
- durable hardened steel studs provide sure grip traction

Great for Employee Safety Programs!

Easy to See on Camera

- Part No.
- SSBO-M** Boot/Shoe Size 5-7
 - SSBO-L** Boot/Shoe Size 8-10
 - SSBO-XL** Boot/Shoe Size 11-13
 - SSBO-XXL** Boot/Shoe Size 14+



Designed to Save a Life!



Deluxe Retractable Polar Picks Ice Safety Picks

- Retractable heads cover the picks when not being used.
- Super grip EVA Handles
- Non-Stretch extra long lanyard
- Super strong steel picks for sure grip
- Ice safety instructions included !

Part No. **PLD-10**

Premium Sport Lanyard

Part No. **HTSL-1**

- Classic black multi-purpose flat polyester
- Premium metal swivel hook
- Traditional 36" length; 3/4" width



Polar Picks Ice Safety Picks

Part No. **PL-10**

- Can be carried in any accessible pocket.
- Compact and lightweight (5 in. long and only weighs 4 oz.)
- 30" long nylon cord connects the 2 Ice picks



NORDIC LAZER LIGHT

Part No. **NLL-1**

- Extra bright LED system
- Great for re-charging items that glow like glow jigs
- Great for a quick light source
- Included 4 each LR41 button style alkaline batteries

Re-Charge Glow Jigs



Part No. **NCL-5SK**
Holds 50 Cap Lights



Clip-On 5 LED Cap Light



Pivoting Head

Camo Color
Part No. **NCL-5**
Multi-LED Model
Red • Green • White



HAT NOT INCLUDED

- Three Settings:
- 1 White LED on
 - 2 Green LEDs on
 - 3 Red LEDs on



Part No. **NCL-5WSK**
Holds 50 Cap Lights



Pivoting Head
Black Color

- 2 - #2032 - 3 Volt Batteries Included
- Light up any dark place hands free!
- Clips on all cap brims. Easy On and Off.

Part No. **NCL-51W**
White-LED Model
5 White LEDs on All the Time

Part No. **NCL-5W**
White-LED Model
5 White LEDs

- Three Settings:
- 3 LEDs on
 - 5 LEDs on
 - 5 LEDs flashing



Part No. **LCL-4SK**
Holds 50 Cap Lights



Premium LED Cap Light

Clip-on cap light features adjustable pivoting head to direct light precisely where desired – and a USB cord to recharge batteries!



HAT NOT INCLUDED



2.5 Hrs. of Continuous Runtime on a Single Charge

Part No. **LCL-4**

- Super bright premium L.E.D. cap light - clips securely to brim of any cap
- Multiple settings – dim - bright - flashing white L.E.D.'s or 4 led blue light
- Includes convenient usb cord for re-charging of batteries

HT JACKETS AND BIBS

- Superior material that helps your body maintain its natural warmth
- Fully sealed seams
- Lightweight, water proof & breathable
- Advanced zipper system that breaks ice !
- Articulated built-in padded knees
- Highly Reflective 600 Lux material - can be seen from far distances !
- Strategically designed large pockets
- "Zip to the Hip" Zipper System allows for easy changing without removing boots
- Padded seat for "all-day" comfort
- Adjustable comfortable neoprene cuffs to keep the elements out
- Hood includes a front bib extension with a wrap around neck and face warmer



Part No.

HTJ-M - HT COLD WEATHER JACKET-MEDIUM

HTJ-L - HT COLD WEATHER JACKET-LARGE

HTJ-XL - HT COLD WEATHER JACKET-EXTRA LARGE

HTJ-2X - HT COLD WEATHER JACKET-2X

HTJ-3X - HT COLD WEATHER JACKET-3X

HTJ-4X - HT COLD WEATHER JACKET-4X

HTB-M - HT COLD WEATHER BIBS-MEDIUM

HTB-L - HT COLD WEATHER BIBS-LARGE

HTB-XL - HT COLD WEATHER BIBS-EXTRA LARGE

HTB-2X - HT COLD WEATHER BIBS-2X

HTB-3X - HT COLD WEATHER BIBS-3X

HTB-4X - HT COLD WEATHER BIBS-4X



HT Mesh Hat



Part No.
HTSC-100

- 4 panel mesh back
- Adjustable snap back
- Super strong bill
- One size fits all design
- Great for year round use

HT Premium Hat



Part No.
HTC-100 Small/Medium
HTC-200 Large/Extra Large

- Flexible fit
- High stitch count
- Super strong bill
- Great for year round use

HT Cuffed Knit Cap



Part No.
DKH-10

- Custom knit with cuff
 - Hi-Viz knit in logo
 - Stretch fit/one size fits all
- MADE IN THE USA**

HT Deluxe Beanie



Part No.
HT10-A

- Lightweight, soft comfortable fit
- Polar TX insulation
- Exclusive moisture management keeps you dry and warm

HT Hoodie

- High stitch count for maximum warmth
- Hood with draw cord
- Large front pouch pocket



Front

Back

Part No.
HTH-S Small
HTH-M Medium
HTH-L Large
HTH-XL Extra Large
HTH-2X 2 Extra Large
HTH-3X 3 Extra Large
HTH-4X 4 Extra Large

HT Performance Hoodie



- Fully dye-sublimated hood with draw cord
- Polyester performance fleece lining
- Fully dye-sublimated body and logo
- Large front pouch pocket



Part No.
HTPH-S Small
HTPH-M Medium
HTPH-L Large
HTPH-XL Extra Large
HTPH-2X 2 Extra Large
HTPH-3X 3 Extra Large
HTPH-4X 4 Extra Large
HTPH-5X 5 Extra Large

APALS® LIGHT WHERE YOU NEED IT!

HT 
WWW.HTENT.COM™
 CUTTING EDGE HI-TECH LIGHTING TECHNOLOGY



- Can be seen up to 2 miles horizontal and 3 miles from the air
- Runtime: Up to 200 Hours
- Modes: Fast Flashing / Slow Flashing / Steady On / Off
- Heavy Duty 3M® Adhesive Back
- Easy-Pull Tab
- Waterproof, Dustproof & Shockproof



○ ALL PURPOSE ADHESIVE LIGHT STRIPS

APALS® portable light strips are a much "greener" alternative to chemical light sticks as they can be turned off and on and reused many times compared to a one time use chemical light stick. They can be used to light your tackle box, cooler, fishing rod holders or anywhere you require super bright, long lasting lighting. APALS® multi-purpose light strips can reduce volume and weight in your tackle box as they replace several lighting tools with their versatility. APALS® will provide up to 200 hours of light and weighs less than a fraction of an ounce. The highly polished aluminum surface is a great daytime signaling mirror. The bright LEDs with fast and slow flashing modes are highly effective at night for signaling a rescue team. APALS® portable light strips are easy to carry in and carry out and are an essential piece of gear in any tackle box.

MODEL NUMBERS:

- APAL-1W APALS 1/pkg white LED
- APAL-1W-72 APALS 1/pkg 72 each per sidekick white LED



200 HOURS
Up to 200 hours runtime.



HEAVY DUTY ADHESIVE BACK
Heavy Duty 3M® Adhesive Back.

3M® is a registered trademark of 3M® corporation.



MANUAL SWITCH
Steady on, fast flashing, slow flashing and off modes.



PATENT NUMBERS: 9,013,100B2 - 9,030,085B2 - 9,221,594B2 - 9,206,969B2

Powered By
BRITE STRIKE



**Nothing Beats
Ice Fishing . . .
Nothing !**

WWW.HTENT.COM

TO ORDER CALL

800-216-5184

Please Place Orders Before *March 1st 2022*

Catalog # 2022W

HT ENTERPRISES, INC. • PO BOX 909 • CAMPBELLSPORT • WISCONSIN 53010

PHONE: 800-216-5184 • FAX: 920-533-5147

SHIPPING ADDRESS: 139 EAST SHEBOYGAN STREET